

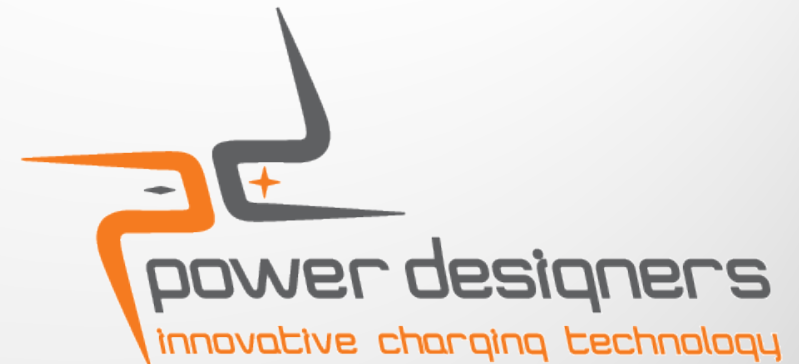

# Introducing the REVOLUTION Charger

This material is provided by Power Designers USA LLC

[www.powerdesigners.com](http://www.powerdesigners.com)



# Revolution Series

## Features

---

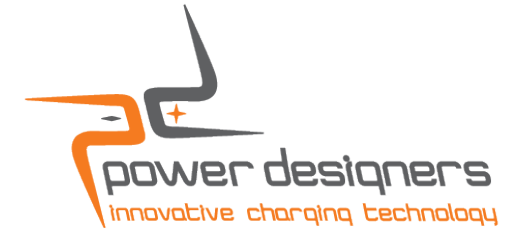

Scalable, Light Weight Efficient, Customizable, Programmable, and Reliable full line of Smart Battery Chargers

- + Three Basic Building Blocks, RV05, RV08, RV12 configurable from 4-31kW
- + Multi-voltage, (24V, 36V, 48V) on a single charger when combined with the PowerTrac
- + Modular design allows for easy configuration and servicing



# Revolution Series

## Efficiency

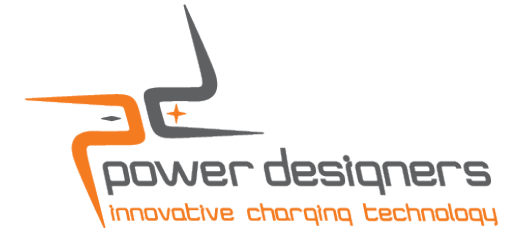

- + Maintain charge efficiency greater than 90% over the entire charge cycle
- + Small and lightweight construction
- + Supports conventional, opportunity, and fast charge applications
- + Customizable through software and hardware configuration

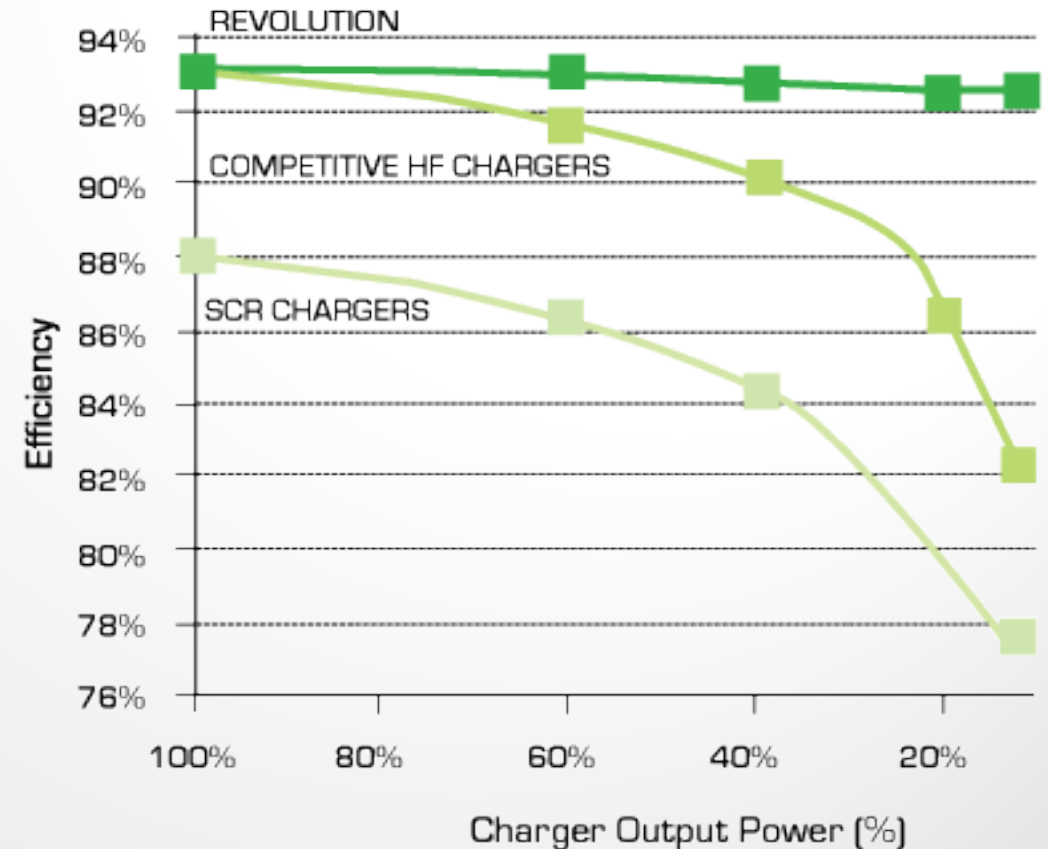

# Revolution Series

## Modularity

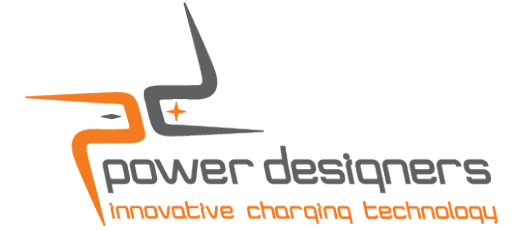

- + Individual 1.3kW power modules
- + BPUs are either 36/24 volt or 48/36/24 volt output
  - 36 volt BPU produces 30 amps
  - 48 volt BPU produces 22.5/25 amps
- + Modules can be configured to meet the exact needs of the customer
- + Fault tolerant design that allows the charger to continue operation if a power module fails

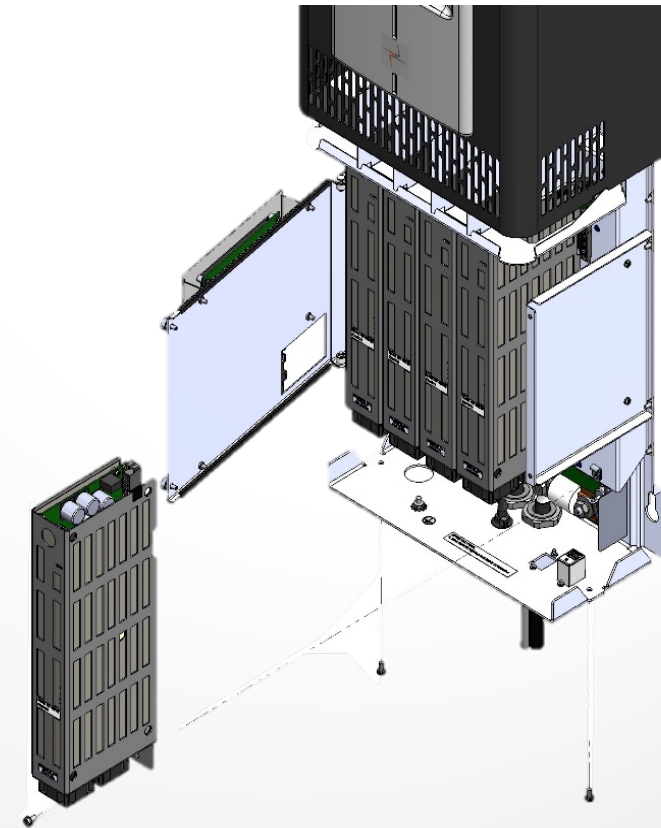

# Revolution Series

## Modularity

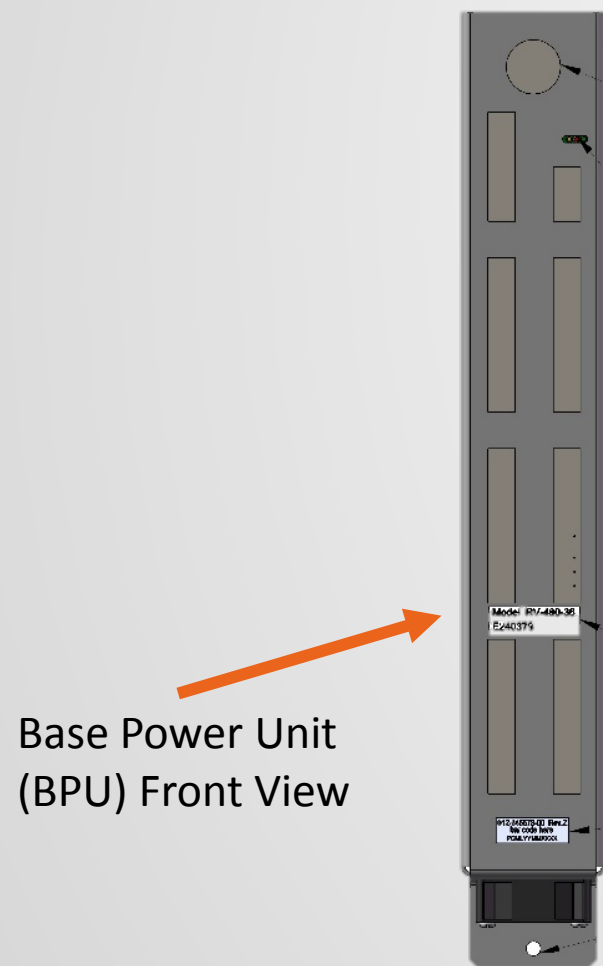
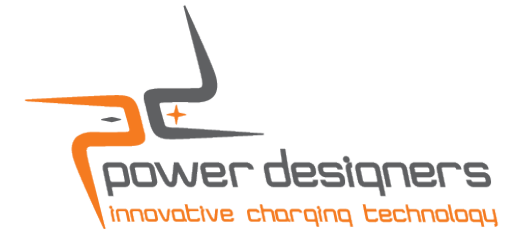

Base Power Unit (BPU) Front View

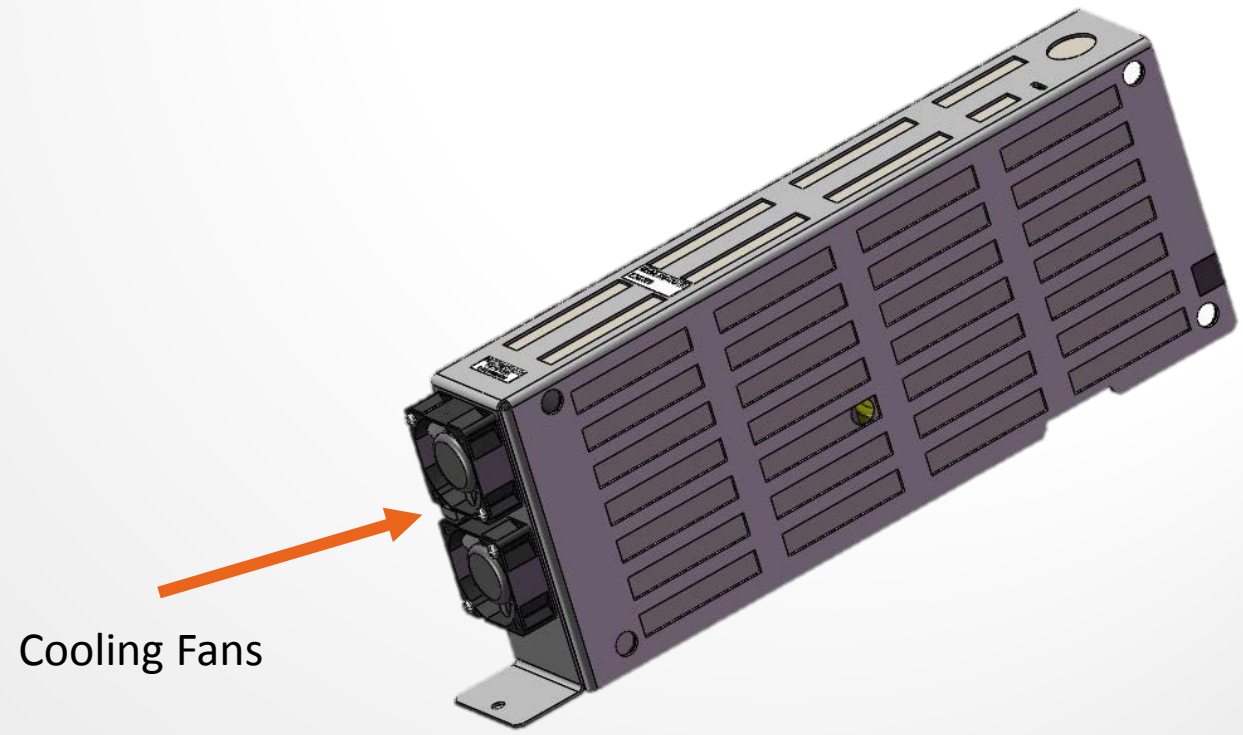

Cooling Fans

# Revolution Series

## Redundancy

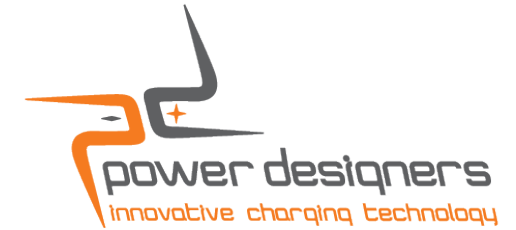

- + If a module faults during the charging cycle, the fault is recorded, and the charge cycle continues.
- + The Charger will continue to operate, so long as 60% of the installed modules are operational.
- + A Warning Symbol will be displayed on the upper right of the display while the charge cycle is under way.

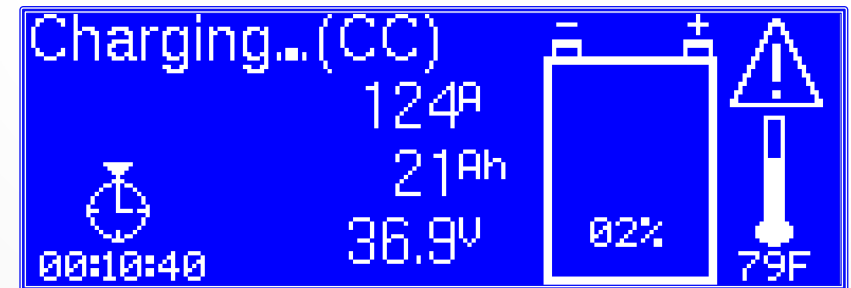

# Revolution Series

## Quiz Time

---

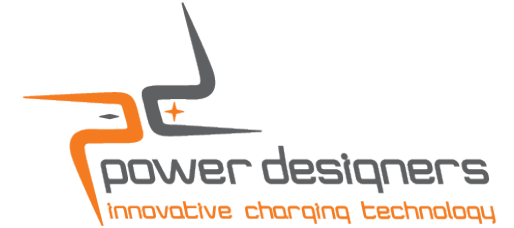

What are the 3 basic building block chassis sizes of the Revolution series charger?

The RV05, RV08, and RV12; a 5 module, 8 module and 12 module chassis respectively

As output power decreases, charger efficiency increases or decreases?

Decreases

The Revolution series maintains efficiency above \_\_\_\_\_ percent as power decreases?

90%

The modular design provides two benefits, what are they?

Scalability and Redundancy

# Revolution Series

## Charger Display

---

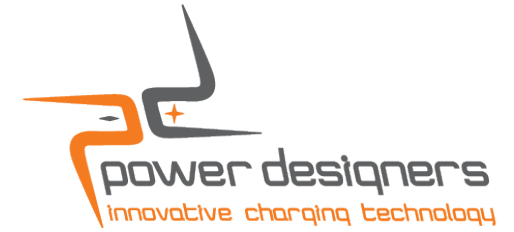

While the battery is disconnected the charger will display the Connect Battery screens, alternating between the animation and message

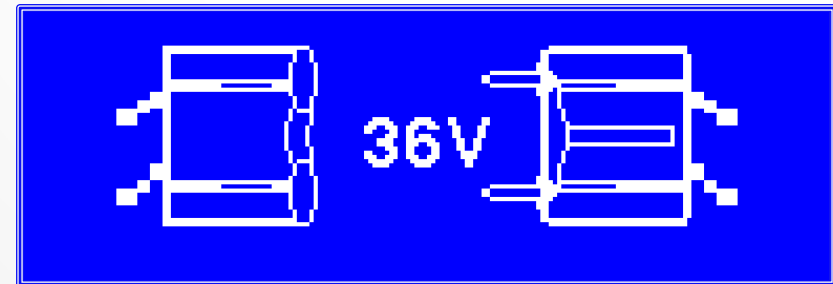



# Revolution Series

## Charger Display

---

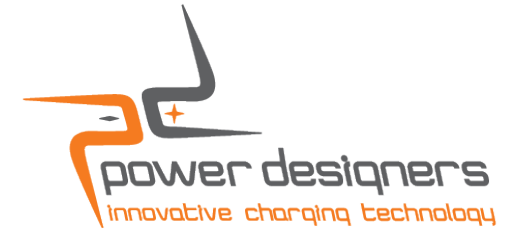

Connect the battery to the charger. Once the battery is detected, one of two messages appears on the LCD:

1. The LCD displays the **PUSH START** screen.



If the charger is not set to start automatically, start the charge cycle by pushing the green **START** button on the keypad.



# Revolution Series

## Charger Display

---

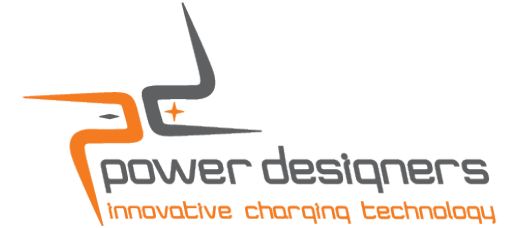

2. If **Charge Autostart** is enabled, the charger automatically starts the charge cycle, and briefly displays an **AUTO START** with a timer count-down message as shown below. The timer will count down from 5 to 1 before the charge cycle starts.



# Revolution Series

## Charger Display

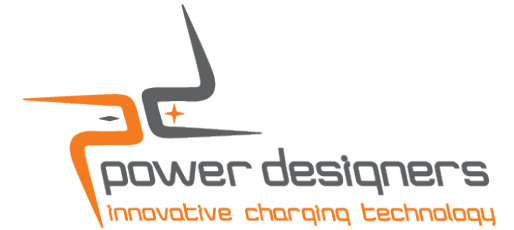

The charge cycle begins and a screen similar to one of the following, showing the charging operation, appears:

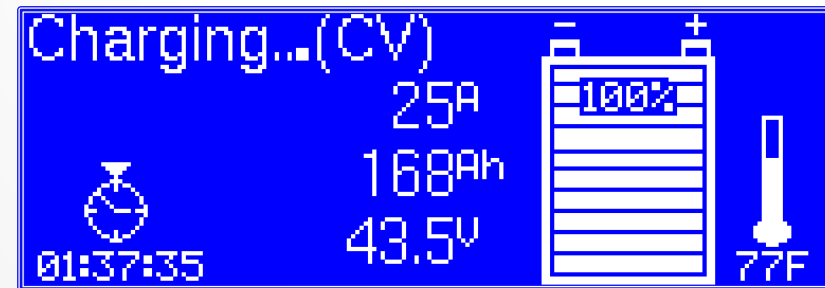
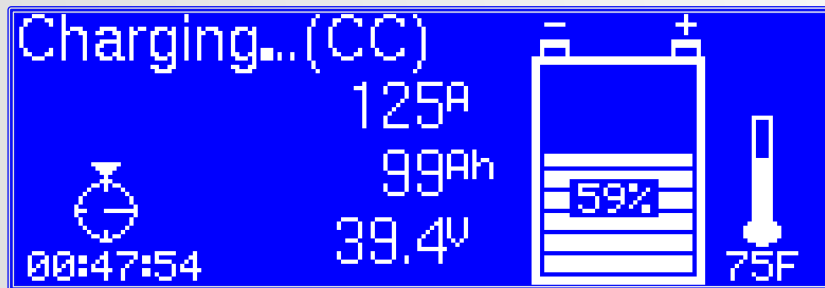

# Revolution Series

## Charger Display

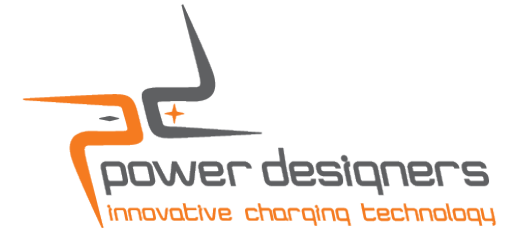

The **Charging ... (XX)** field in the upper left corner indicates the active charging mode, the **XX** will indicate:

- + **TR** for trickle
- + **CC** for constant current
- + **CV** for constant voltage
- + **FI** for finish
- + **EQ** for equalize

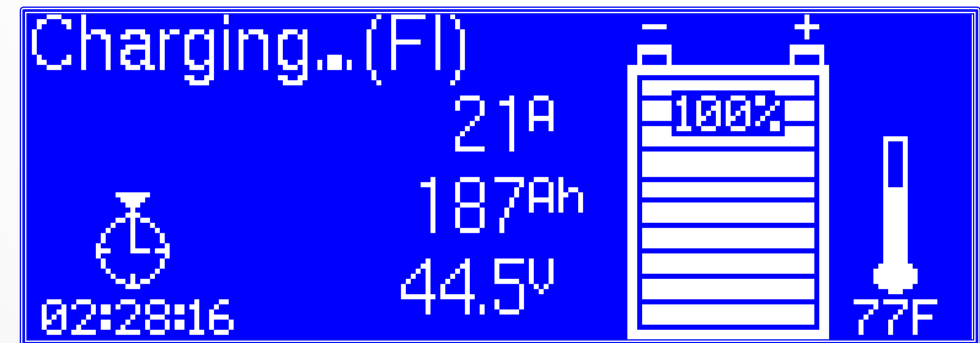

The screen also displays:

- + Charge timer (lower left)
- + Battery icon with % state of charge gauge
- + Charging amps (**A**)
- + Returned amp-hours (**AH**)
- + Battery voltage (**V**)
- + Thermometer icon with the current battery temperature (°F or °C) (lower right)

# Revolution Series

## Charger Display

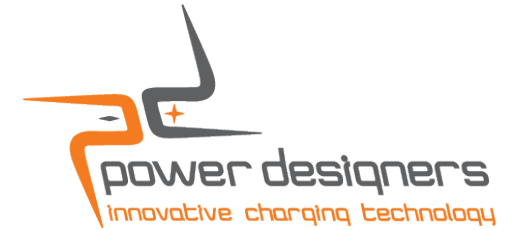

- + To stop the charge cycle, select the **STOP** button. A **PAUSED** message appears.
- + Selecting **START** from the **PAUSED** screen will resume the charge cycle.
- + The cycle can be terminated by pressing stop a second time. Disconnecting the battery while paused also terminates the cycle.

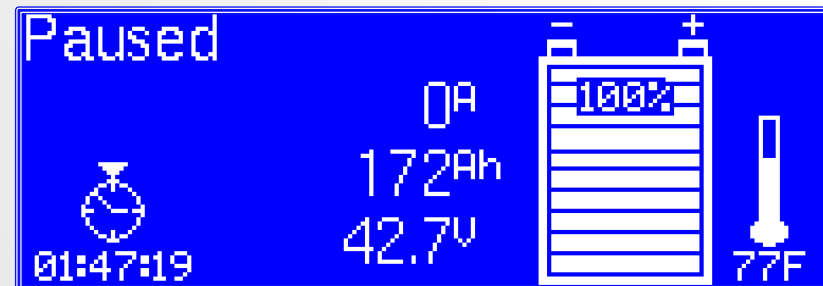

# Revolution Series

## Charger Display

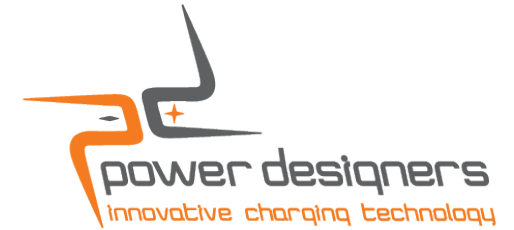

- + Once the charge cycle has completed, the charger displays the CYCLE COMPLETED screen.
- + On this screen appears the total charging time and total returned amp-hours along with the final state of charge of the battery.

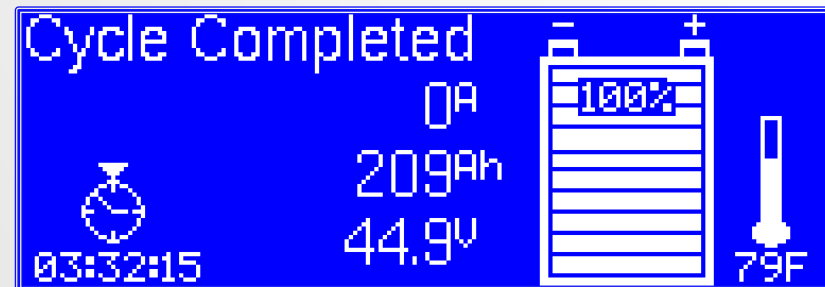

# Revolution Series

## Charger Display Menu

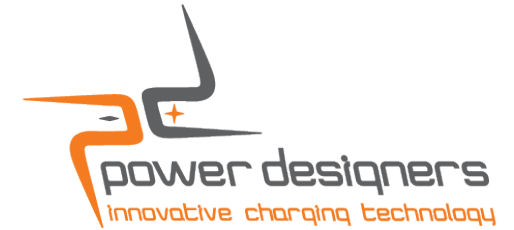

From the charger MAIN MENU screen, access is provided to the following list of menus screens:

- + Manual Equalize
- + Desulfation Cycle
- + Charge History
- + Lifetime Summary
- + Model & SN

Manual  
Equalize

Charge  
History

Model  
& SN

Desulfation  
Cycle

Lifetime  
Summary

# Revolution Series

## Charger Display Menu

---

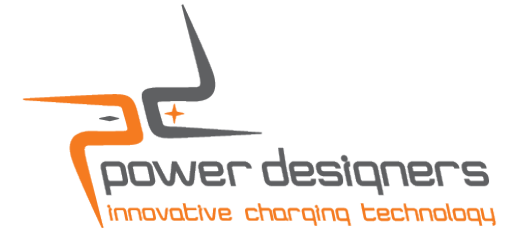

Pushing the **ENTER** key selects the charger **MAIN MENU** screens.



The up/down arrow (▲/▼) keys scroll between the various screens.



The **BACK** button is used to return to the previous screen and/or back to the main menu.



Selecting the **ENTER** button within a main menu will select a setting, go to the next screen, or toggle between two screens.



# Revolution Series

## Charger Display Manual Equalize

---

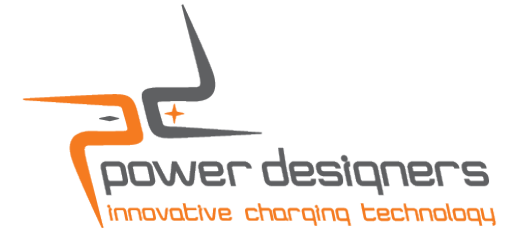

While in **MAIN MENU**, press ▲/▼ until the **MANUAL EQUALIZE** screen appears.



Press **ENTER** to access screen.

Press ▲/▼ to select **YES** or **NO**.

Press **ENTER** key to save selection and return to the main menu.



# Revolution Series

## Charger Display Manual Equalize Selected and Active

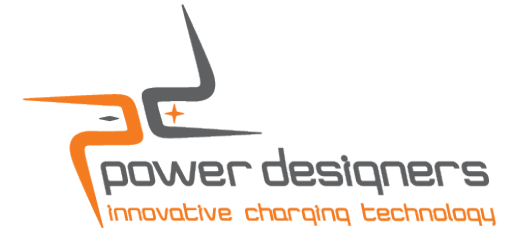

The LCD display now indicates the Equalization charge is activated with an “E” in the upper right corner of the display, and one of the following displays will be observed, depending on the setup of the Charger.

**NOTE: Once an Equalization is activated, it remains active until an equalization cycle has completed.**

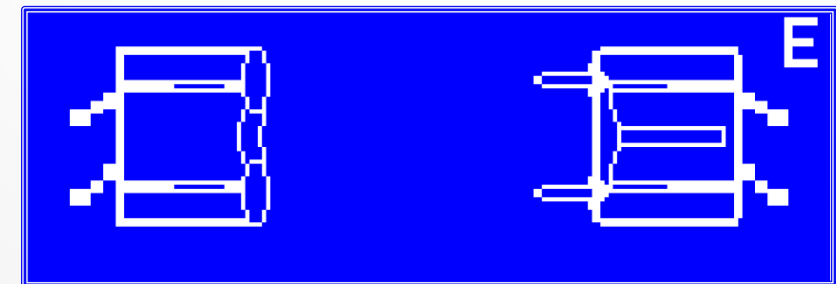

# Revolution Series

## Charger Display Desulfation Cycle

---

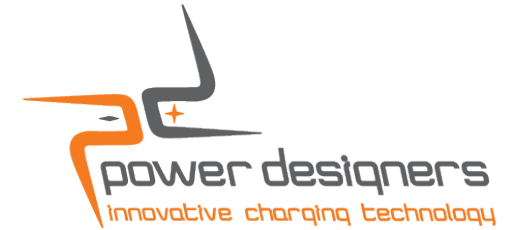

A unique feature of the all Power Designers chargers is the ability to run a safe, tailored recovery cycle for sulfated batteries. This can easily be done through the **DESULFATION CYCLE** screen.

Connect the battery to be recovered. If the charger is set to auto-start the charge cycle, press the stop button until you are back on the “Push Start” screen.

While in **MAIN MENU**, press ▲/▼ until the **DESULFATION CYCLE** screen appears. Press **ENTER** to access the recovery cycle set-up screens.

**NOTE: Do not attempt to recover a battery of less than 250 amp-hours.**



# Revolution Series

## Charger Display Setting the Desulfation Cycle

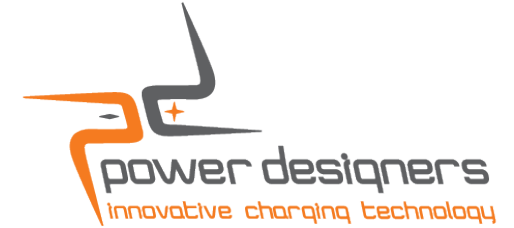

The first screen selects the appropriate battery voltage. Pressing ▲/▼ toggles the battery voltage setting. Select the correct voltage and select **ENTER**.



The **Battery Capacity** screen appears. Pressing ▲/▼ allows the user to enter the correct battery amp-hour capacity. The recovery charge current is fixed at 5A /100 Ahrs (5% of rated capacity). Press the **ENTER** key once the correct value is selected.



# Revolution Series

## Charger Display Setting the Desulfation Cycle

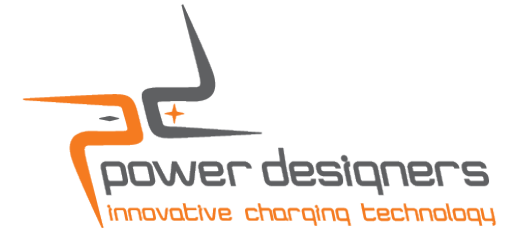

The **Cycle Duration** timer screen appears. Pressing ▲/▼ allows adjustment of the charge timer setting in 15-minute increments. The charge timer setting must be less than 24 hours. Select the desired value, then select **ENTER**.



Next, the **START DESULFATION CYCLE** screen appears. Push **START** to initiate the desulfation cycle.

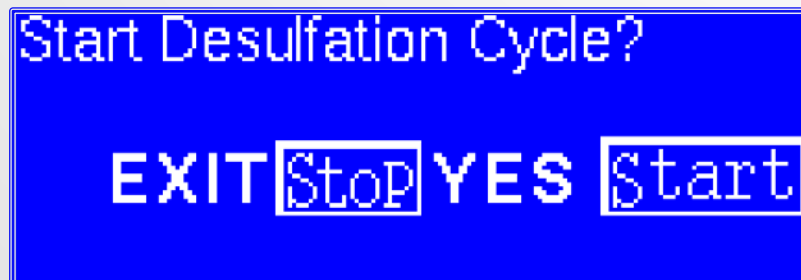

# Revolution Series

## Charger Display Setting the Desulfation Cycle

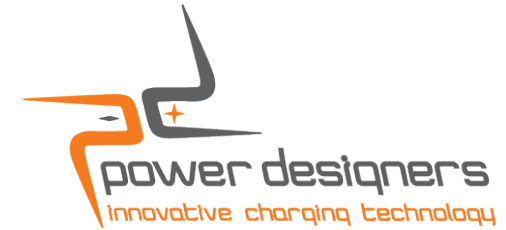

Charger screen during desulfation cycle

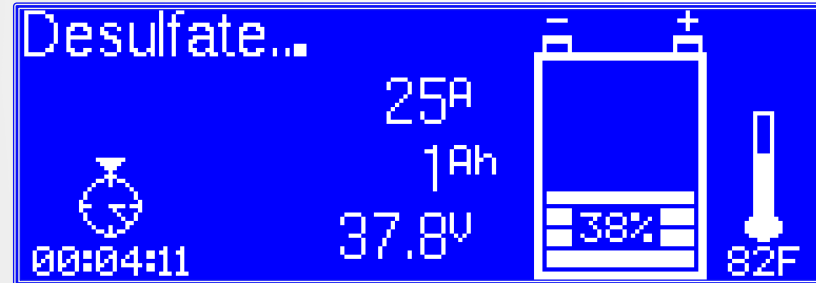

Once the cycle is complete, a **CYCLE COMPLETED** message appears.

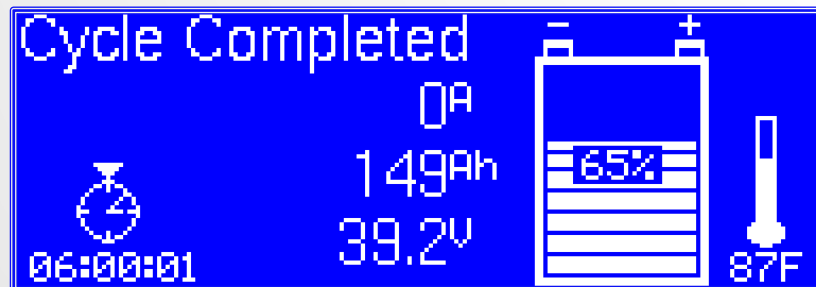

**NOTE: The desulfation cycle is a separate cycle; activating it does not affect other charger settings. See Appendix E of the manual for instructions on how to determine the recovery charge current and timer setting.**

# Revolution Series

## Charger Display Charge History

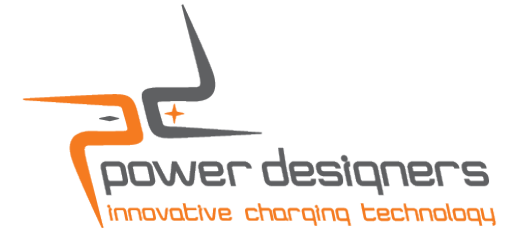

While in **MAIN MENU**, press ▲/▼ until the **CHARGE HISTORY** screen appears. Press **ENTER** to access the **Charge History** screens.



The first screen that appears is the Charge Cycle history screen as shown below. Users can access the charge history for up to 400 charge cycles, beginning with the most recent charge cycle. Pressing ▲/▼ allows scrolling through the saved charge cycles, from the most recent cycle to the earliest (Charge 0), in descending order.

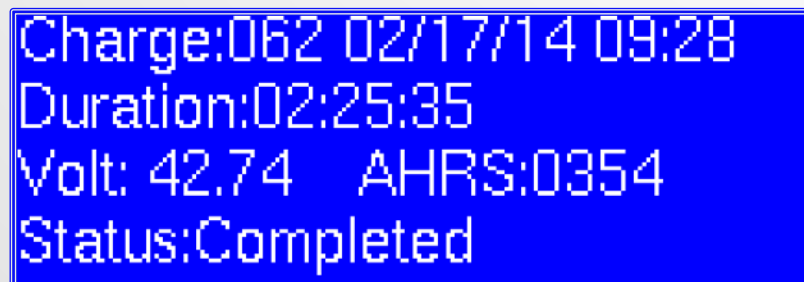

# Revolution Series

## Charger Display Charge History

---

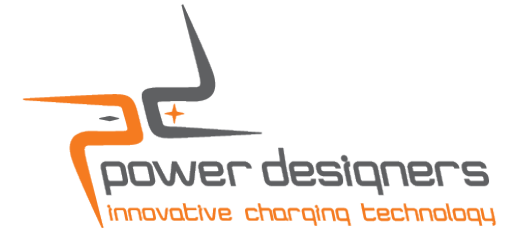

The first screen of the charge history displays:

- + The charge number
- + The date and time when the charge was started
- + The charge duration
- + End battery voltage
- + The total amp-hours returned to the battery
- + The charger status

```
Charge:062 02/17/14 09:28
Duration:02:25:35
Volt: 42.74  AHRS:0354
Status:Completed
```

**STATUS** indicates whether the cycle was completed successfully (**COMPLETED**), interrupted by the user (**STOPPED**), interrupted due to a power outage or disconnection (**TURNED OFF**), or interrupted due to a fault (e.g., **OV FAULT** for an over voltage fault).



# Revolution Series

## Charger Display Charge History

---

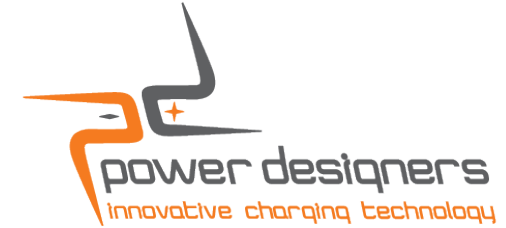

Press **ENTER** to access the second screen of the charge history which shows:

- + The profiles that were activated in the charge cycle
- + Any Charger faults

A screenshot of a blue LCD display with white text. The text is arranged in two lines: "Charge:062 02/17/14 09:28" on the top line and "Profiles: TR CC CV" on the bottom line. The display is framed by a thin blue border.

Pressing **ENTER** again will return to the first screen. Pressing the **BACK** key returns to the **CHARGE HISTORY** screen from the first screen only.

**PROFILES** lists the profiles activated during the charge cycle. Trickle charge appears as **TR**, constant current as **CC**, constant voltage as **CV**, finish as **FI**, and equalize as **EQ**.

# Revolution Series

## Charger Display Lifetime Summary

---

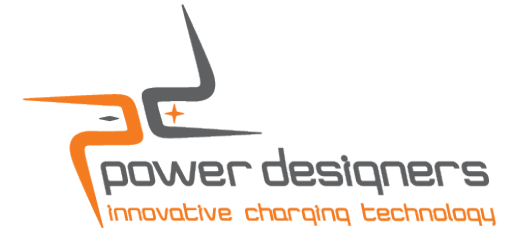

While in **MAIN MENU**, press ▲/▼ until the **LIFETIME SUMMARY** screen appears.



Pressing the **ENTER** key will display a screen summarizing charger lifetime summary statistics since installation.

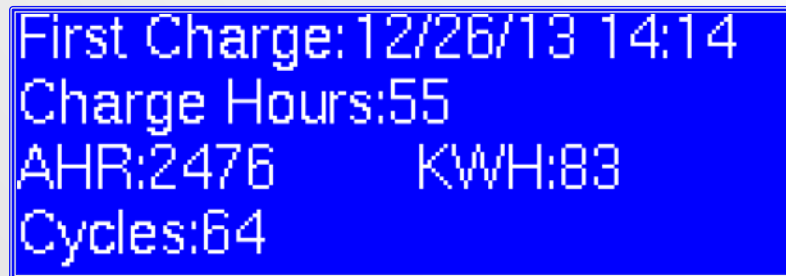

# Revolution Series

## Charger Display Model and Serial Number

---

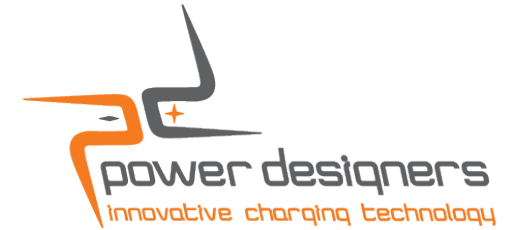

While in **MAIN MENU**, press ▲/▼ until the **MODEL & SN** screen appears.

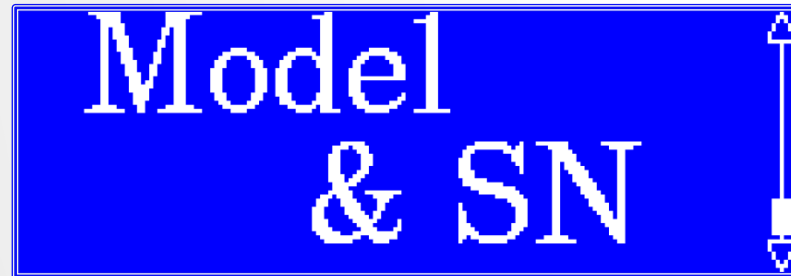

Pressing the **ENTER** key displays the charger model number, manufacturing ID, and firmware revision for reference.

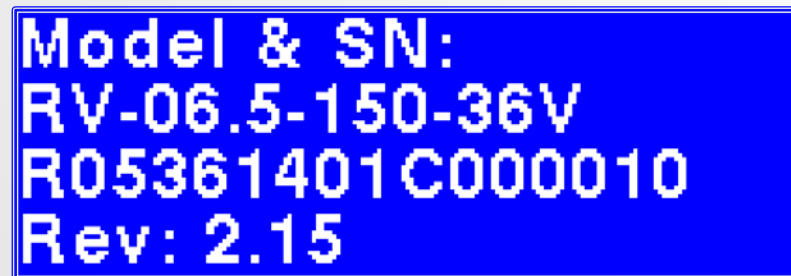

# Revolution Series

## Another Short Quiz

---

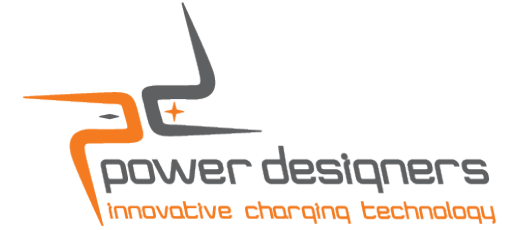

The charger history saves and displays how many cycles?

400

Manual Equalize remains active for how long?

Until an Equalize cycle is completed

What is shown on the display to indicate Manual Equalize?

An “E” in the corner of the display

Name the one feature of all Power designers chargers not found elsewhere?

Desulfation cycle

Thank You  
On Behalf of  
Power Designers  
For Your  
Participation