

**powercharge™**

**BATTERY CHARGER**

***iHF3 Series***



**480 V Models**

**PCiHF-10kW-yyyA-zzV**

**Installation & Operation Manual**



4005 Felland Road, Suite 116  
Madison, WI 53718  
USA

© Power Designers USA LLC

# TABLE OF CONTENTS

<b>POWERCHARGE™ IHF3 SERIES .....</b>	<b>1</b>
<b>SAFETY PRECAUTIONS.....</b>	<b>2</b>
<b>POWERCHARGE™ IHF3 SPECIFICATIONS .....</b>	<b>5</b>
<b>INSTALLATION PROCEDURE.....</b>	<b>7</b>
<b>Charger Installation .....</b>	<b>7</b>
<b>Charger Electrical Installation.....</b>	<b>14</b>
<b>OPERATION PROCEDURE.....</b>	<b>17</b>
<b>Charger Controls and User Interface .....</b>	<b>17</b>
<b>Getting Started .....</b>	<b>18</b>
<b>Charger Main Menu.....</b>	<b>22</b>
<b>TROUBLESHOOTING .....</b>	<b>32</b>
<b>RETURN MATERIAL PROCESS .....</b>	<b>400</b>
<b>CHARGER PROGRAMMING.....</b>	<b>411</b>
<b>WARRANTY INFORMATION.....</b>	<b>59</b>
<b>SOFTWARE LICENSE AGREEMENT .....</b>	<b>621</b>
<b>APPENDIX A – WALL MOUNT DIMENSIONS AND CLEARANCES .....</b>	<b>632</b>
<b>APPENDIX B – POST STAND DIMENSIONS AND CLEARANCES.....</b>	<b>643</b>
<b>APPENDIX C – SHELF STAND DIMENSIONS AND CLEARANCES.....</b>	<b>654</b>
<b>APPENDIX D – RECOVERY CYCLE FOR SULFATED BATTERY CURRENT AND TIMER SETTINGS.....</b>	<b>665</b>
<b>APPENDIX E – NOTE ON TEMPERATURE COMPENSATION .....</b>	<b>676</b>
<b>CONTACTING POWER DESIGNERS USA LLC .....</b>	<b>687</b>

## POWERCHARGE™ iHF3 SERIES

The **PowerCharge™ iHF3** series of three-phase, high-frequency smart chargers incorporates **Metal-Oxide Semiconductor Field-Effect Transistor (MOSFET)**, **Insulated Gate Bipolar Transistor (IGBT)** technology, and high-frequency transformers, providing high electrical efficiencies (92% charging efficiency and 96% power factor) in a compact package. **PowerCharge™ iHF3** chargers are the lightest and most-efficient chargers available on the market.

The **PowerCharge™ iHF3** chargers support standard, opportunity, and fast charge cycles. iHF3 chargers also offer programmability. All charger settings and features can be easily customized to match workloads and schedules. Finish and equalize cycles may be automatically programmed to run on certain days of the week. Additionally, **PowerCharge™ iHF3** chargers may be tailored to meet the needs of any battery chemistry, including flooded, gel, and **Absorbed Glass Mat (AGM)** lead-acid batteries.



**PowerCharge™ iHF3 480 VAC Battery Charger**

# SAFETY PRECAUTIONS

## BEFORE ATTEMPTING TO INSTALL AND OPERATE THE CHARGER, READ THIS MANUAL CAREFULLY

This manual contains important instructions for the **PowerCharge™ iHF3** series product line that shall be followed during installation and operation of the charger. Only qualified personnel should install, operate, or service this equipment.

### SAVE THESE INSTRUCTIONS



- **High Voltages.** Lethal voltages are present within the charger enclosure whenever the AC line is energized and/or the battery/load is connected. The heat sinks and other internal components present the risk of electric shock.
- **Stored Energy.** To avoid the risk of electric shock, wait at least two minutes after de-energizing the AC line and disconnecting the battery/load before removing the cover.
- **High Current Levels.** Do not touch uninsulated battery connectors or terminals. All tools should be adequately insulated to avoid the possibility of shorting connections. Inspect cables often for damage to the insulation. Replace cracked or worn cables immediately.
- **Improper Connections.** If the charger is incorrectly wired to input or output devices or wiring is not in accordance with local safety codes and standards, the iHF3 charger and/or its components are at risk of being destroyed.
- **Grounding.** The charger must be connected to an AC power supply incorporating an earth or ground. The grounding conductor must be of a size equal to or larger than the line (phase) conductors.
- **Explosive Gases.** Working in the vicinity of a lead-acid battery is dangerous. Batteries generate explosive gases during charge and discharge. To reduce the risk of ignition, follow these safety instructions as well as those published by the battery manufacturer. To minimize the potential for arcing and to reduce the risk of damage to the connector contacts, it is preferable to connect and disconnect a battery when the charger output is **OFF**.



## WARNING

- **Chemical Hazard.** Working with lead-acid batteries may result in exposure to highly corrosive acid. To protect eyes and skin, use the required **Personal Protective Equipment (PPE)** as mandated by your employer and local regulations. At a minimum, wear safety goggles and skin protection while connecting the battery charger or working in the vicinity of lead-acid batteries.
- **Follow the battery manufacturer's published instructions when installing, charging, and servicing batteries.**
- **Use only with rechargeable batteries.** Do not attempt to charge other battery types; doing so may cause equipment damage and result in serious personal injury.
- **Do not expose the charger to rain or snow.** The charger is **NOT** designed for outdoor use.



## CAUTION

- **Adequate Cooling Required.** To prevent damage from overheating, proper airflow must be ensured. Do not restrict fan inlets or exhaust outlets. Do not mount the charger in a confined space or where the exhaust air will recirculate.
- **No User Serviceable Parts.** If service is required, contact Power Designers USA LLC or its service representative.
- **These instructions assume a certain level of competence by the installer and/or user.** The following practices and codes contain relevant information, and should be consulted for safe installation, testing, handling, and maintenance of rechargeable lead-acid batteries. All applicable state and local codes must be followed.
  - **National Electric Safety Code (NESC)**, ANSI/IEEE C2-2007 (or latest revision). Copies may be obtained by contacting: The Institute of **E**lectrical and **E**lectronics Engineers, Inc. (**IEEE**), Publications Office, 10662 Los Vaqueros Circle, P.O. Box 3014, Los Alamitos, CA 90720  
[www.ieee.org](http://www.ieee.org)
  - **National Electrical Code (NEC)** NFPA-70 (or latest version) available from: National Fire Protection Association, 1 Batterymarch Park, Quincy, MA 02269  
[www.nfpa.org](http://www.nfpa.org)

- **Federal Codes**

29CFR1926.441 Batteries and Battery Chargers

29CFR1910.305 (j) Wiring Methods, Components and Equipment for General Use

OSHA Directive STD 01-08-002, including 29CFR1910.151(c) Medical Services and First Aid; 29CFR1926.50 and 29CFR1926.51, Medical Service and First Aid, and Sanitation, respectively; applicable to electric storage battery charging and maintenance areas.

- **EMC Compliance**

This device complies with Part 15 section 103 of FCC Rules as a digital device used exclusively as a power system in public utilities or industrial plants.

Operation is subject to the following two conditions:

1. This device may not cause harmful interference.
2. This device must accept any interference received, including interference that may cause undesired operation.

# POWERCHARGE™ iHF3 SPECIFICATIONS

## 480 V Model Numbers

PCiHF-10kW-250A-36V  
PCiHF-10kW-250A-48V  
PCiHF-10kW-120A-80V

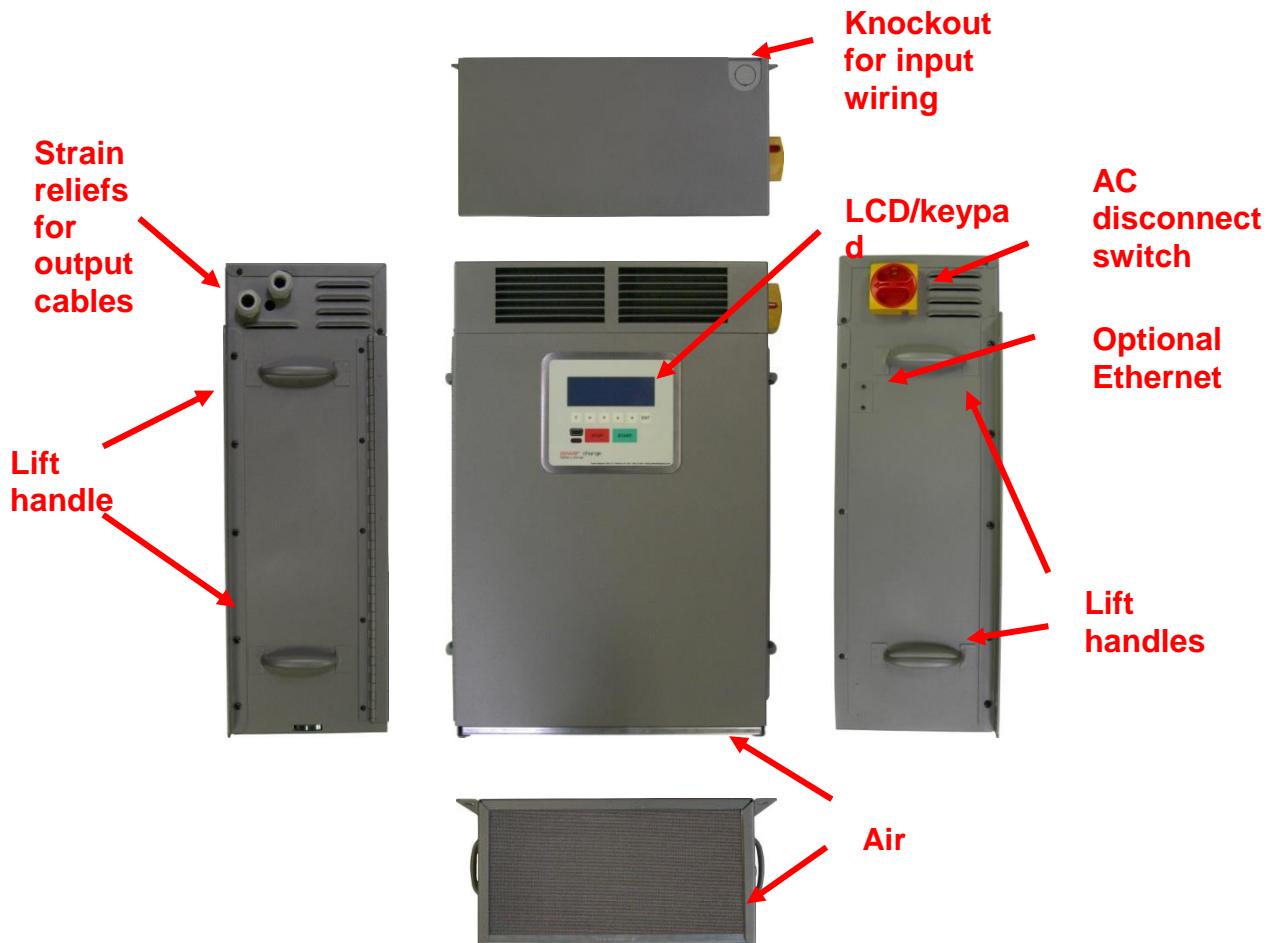


Figure 1: PowerCharge™ iHF3 10 kW Battery Charger features

Specifications for the **PowerCharge™ iHF3 480 VAC** 10 kW models.

<b>Specifications</b>	<b>PCiHF10kW- 250A-36V</b>	<b>PCiHF10kW- 250A-48V</b>	<b>PCiHF-10kW - 120A- 80V</b>
<b>Nominal VA Ratings</b>	36 V / 250 A	48 V / 250 A	80 V / 120 A
<b>Input Specifications</b>			
Voltage	400–480 VAC, ± 10%, 3-phase with earth ground		
Current (Nominal)	13.8 Arms @480 V, 16.7 Arms @400 V		
AC Circuit Size	20 A / 25 A		
Power Factor	0.96 nominal		
<b>Output Specifications</b>			
Voltage	36 V nom. / 62.5 V max.	48 V nom. / 62.5 V max.	80 V nom. / 110 V max
Current	250 A max.	250 A max.	120 A max
Power	10 kW max.	10 kW max.	10 kW max.
Pk-Pk Voltage Ripple	< 1%		
<b>Efficiency (Typical)</b>	92% at full load		
<b>Protection</b>			
Input	<ul style="list-style-type: none"> <li>➤ Under voltage</li> <li>➤ Over voltage transients</li> </ul>		
Output	<ul style="list-style-type: none"> <li>➤ Over current</li> <li>➤ Over voltage</li> <li>➤ Over temperature</li> <li>➤ Battery reverse polarity protection</li> </ul>		
<b>Operating Conditions</b>			
Ambient Temperature	0–40°C		
Humidity	10–90% RH noncondensing		
<b>Interface</b>			
Communication	Isolated RS-232 (Ethernet optional)		
User Interface	LCD/keypad, RS-232, IR		
<b>Cooling</b>	Forced air (fans)		
<b>Mechanical</b>			
Dim. WxDxH	20.1" x 9.3" x 26.3"		
Weight	~ 98 lb		
Output Cabling	2/0 cables		
Output Connectors	SBX w/ aux. contacts or Euro connector		
Auxiliary Contacts	Interface with 5kΩ battery thermistor (optional)		
<b>Certifications</b>	UL and cUL Listed		



# INSTALLATION PROCEDURE

## Charger Installation

The following procedure describes proper installation of **PowerCharge™ iHF3** series chargers.

### Charger Unpacking and Inspection

Upon receipt of the **PowerCharge™**, ensure that there is no physical damage to the chassis, the **Liquid Crystal Display (LCD)**/keypad, the AC disconnect switch, or the DC cables. If any damage is apparent, contact the shipping carrier.



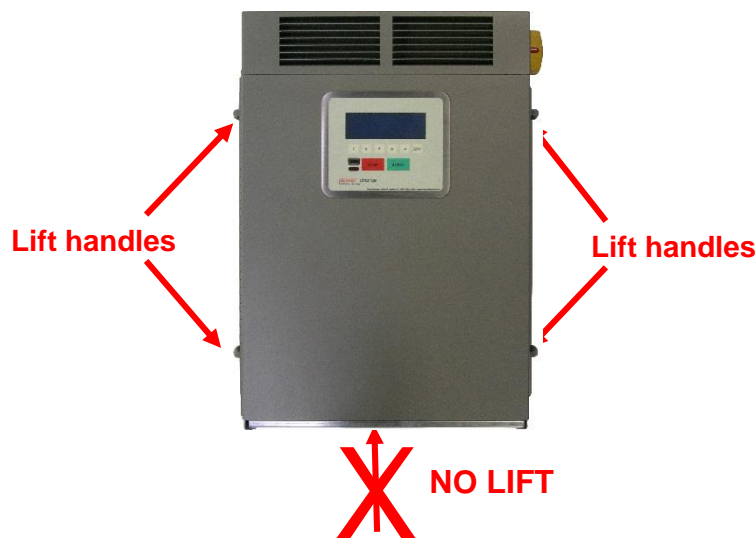
**Do not install or operate the charger if it has any visible damage.**

Ensure that the charging area is well ventilated, dry, and clean.

### 1. Lifting the Charger



**Never lift the charger from the middle of the lower cover, as this will damage the air filter. Use the lift handles mounted on either side of the charger chassis (Figure 2).**



**Figure 2: Charger lifting points**

## 2. Charger Physical Installation

Ensure that the charging area is well ventilated, dry, and clean.

**There must be at least one foot of spacing between the sides of the charger and any adjacent walls or barriers, and two feet of spacing between the bottom of the charger and the floor or any other obstruction.** A minimum of six inches of spacing between the bottom of the charger and the floor is acceptable if using one of the floor stand mounting options. If this option is used, the air filter must be inspected and cleaned more frequently.

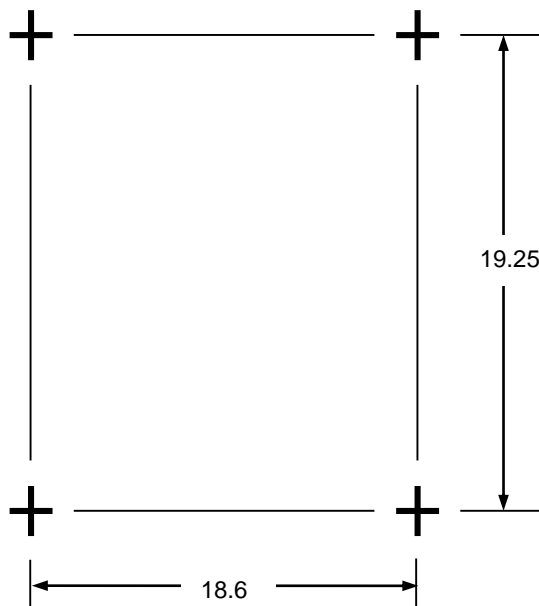


**Do not restrict airflow to the air filter at the bottom of the charger or to the vents at the top of the charger.**

There are three mounting options available for the iHF3 charger: standard wall mount, optional floor-mounted post stand, or shelf stand.

### a. Wall Mount Option

- i. Dimensions and clearances for the wall mount option are shown in Appendix A, page 63 of this manual.
- ii. Using the mounting-hole pattern (Figure 3), mark the locations for the mounting hardware on the wall. Use 1/4-20 fasteners with lock and flat washers to secure the charger to the wall.



**Figure 3: Wall-mount hole pattern**

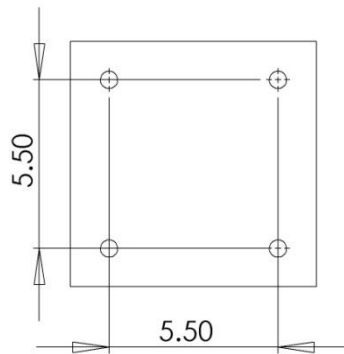
b. Post Stand Option

- i. The post stand (Figure 4) provides a convenient floor-mount option. The charger mounts to the stand using 1/4-20 hardware provided with the post stand. It is also available with a pogo stick cable management system, providing easy connection to the battery and keeping cables off the floor when not connected. Dimensions and clearances are detailed in Appendix B, page 64 of this manual.



**Figure 4: Post stand**

- ii. The post stand should be bolted to the floor using the hole pattern shown (Figure 5). The post-stand base plate has four 0.55-inch diameter holes suitable for ½-inch mounting hardware. **Note that the holes in the upper portion of the base plate section must be on the left and right sides of the installation (Figure 7).**



**Figure 5: Post-stand mounting-bolt pattern**

- iii. The post-stand brackets (Figure 6) are fastened to the inside of the base plate, using the supplied 1/4-20 bolts and lock washers. Finger-tighten only at this time. **Again, note the brackets are on the left and right sides of the installation.**



**Figure 6: Post-stand bracket**

- iv. The upper section of the post stand can now be placed over the top of the base plate and brackets. Note the mounting studs for the iHF3 charger are on the front surface of the upper section. Fasten the upper section to the post-stand brackets with the supplied 1/4-20 bolts and lock washers. All of the bracket bolts can now be fully tightened.

- v. The charger can now be lifted onto the mounting studs of the post stand and fastened with the supplied 1/4-20 nuts and flat washers.

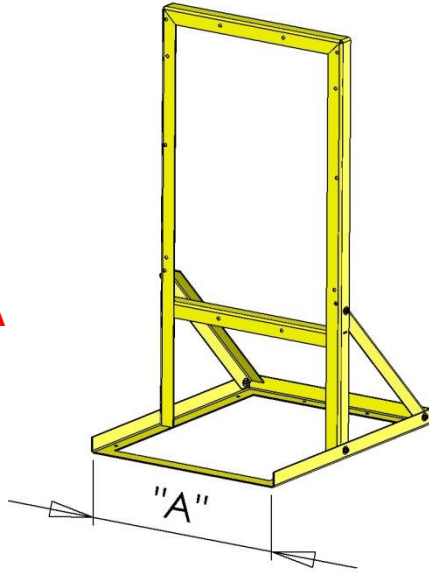


**Figure 7: Assembled post-stand base**

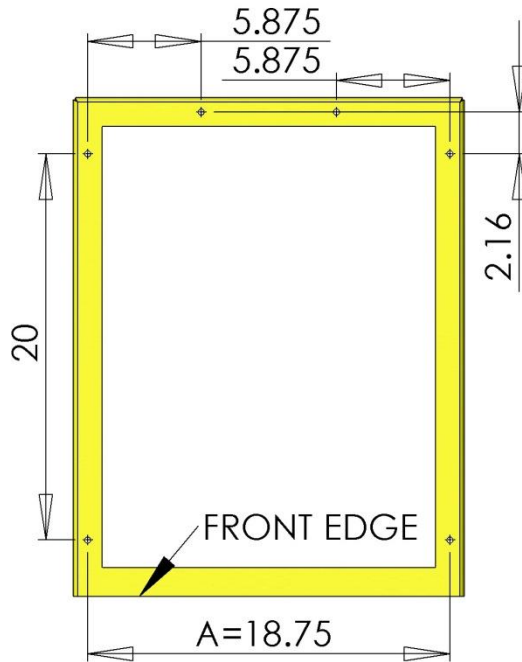
c. Shelf Stand Option

- i. The shelf stand (Figure 8) provides another convenient mounting option. Complete dimensions and clearances are given in Appendix C, page 65 of this manual.
- ii. The shelf stand is typically bolted to open shelving using the hole pattern (Figure 9). The shelf-stand base plate has six 0.31-inch diameter clearance holes for 1/4-20 mounting hardware.

**NOTE:**  
Dimension **A**  
critical for  
open shelf  
mounting



**Figure 8: Shelf stand**



**Figure 9: Shelf-stand mounting-bolt pattern**

### 3. Air Filter

The charger is equipped with an air filter located in the bottom of the chassis. The air filter needs to be checked on a monthly basis and cleaned if needed. If the charger is mounted less than two feet from the floor or other obstruction, the air filter will need to be checked and cleaned more often.

To remove the filter, grasp the open (front) side of the filter, depress the spring retainer on the left side of the charger, and slide the filter out.

**ATTENTION:** Before installing, clean the filter using soap and water and dry thoroughly, or blow out debris in the opposite direction of airflow with compressed air.

To reinstall, slide the filter into the guides and push in until fully inserted (Figure 10).

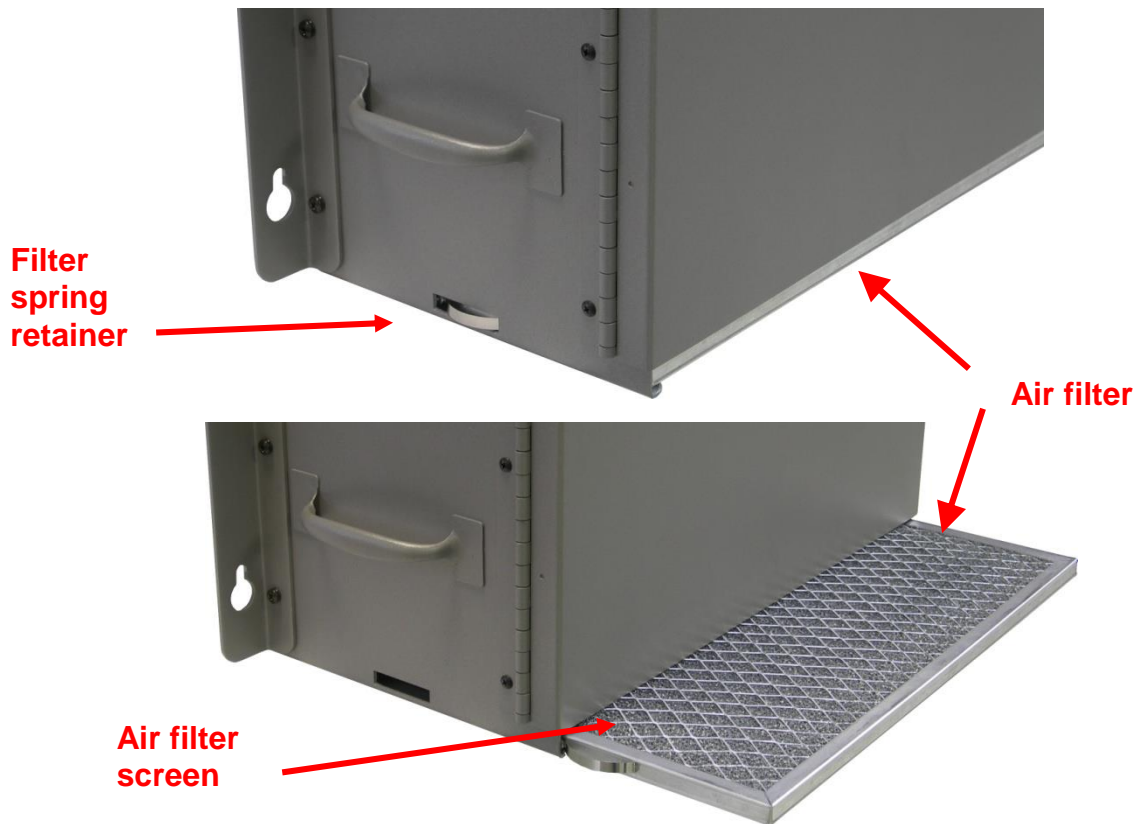


Figure 10: Installing/reinstalling the air filter

**ATTENTION:** When reinstalling the filter or installing a new filter, make sure that the filter side with the wire frame is facing upward. Also, the front of the filter has an arrow showing airflow direction; the arrow should be facing into the charger.

# Charger Electrical Installation



**DANGEROUS VOLTAGES AND CURRENTS ARE PRESENT IN THE AC MAINS WHEN ENERGIZED. ONLY TRAINED PERSONNEL SHOULD PERFORM THESE PROCEDURES, USING PROPER EQUIPMENT AND PROCEDURES.**

**VERIFY THAT INPUT AND OUTPUT WIRING ADHERES TO ALL LOCAL SAFETY CODES AND STANDARDS.**

1. PowerCharge™ iHF3 chargers require a 480 VAC 3Ø, four-wire Wye or Delta electrical supply with a separate ground (Figure 11). Nominal 480 VAC current draw is 13.8 A; circuit disconnect at 125% should be 20 A.

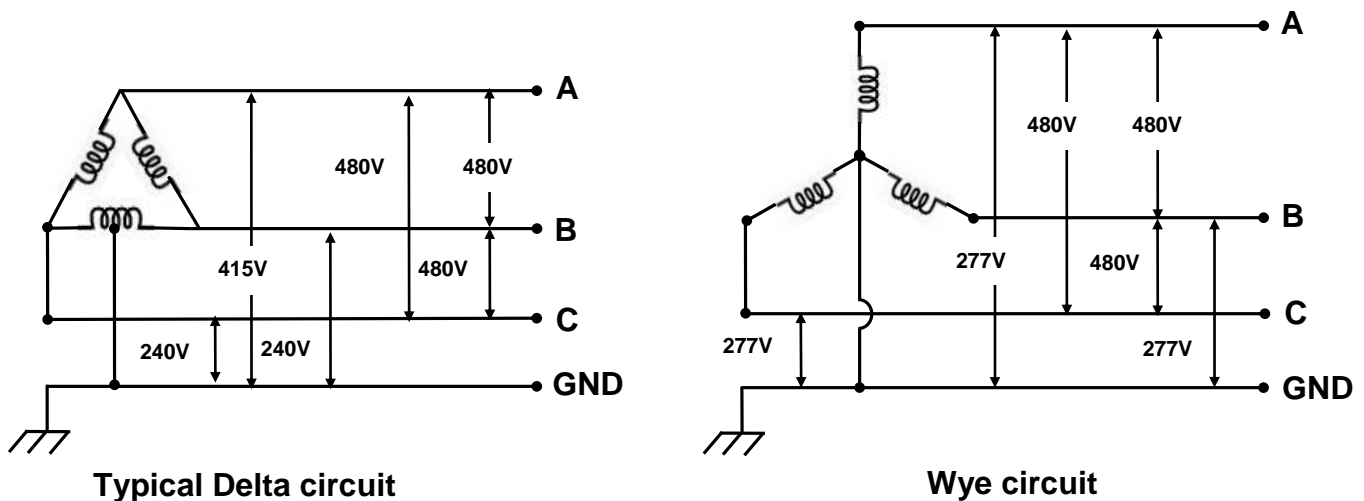


Figure 11: AC input wiring diagrams

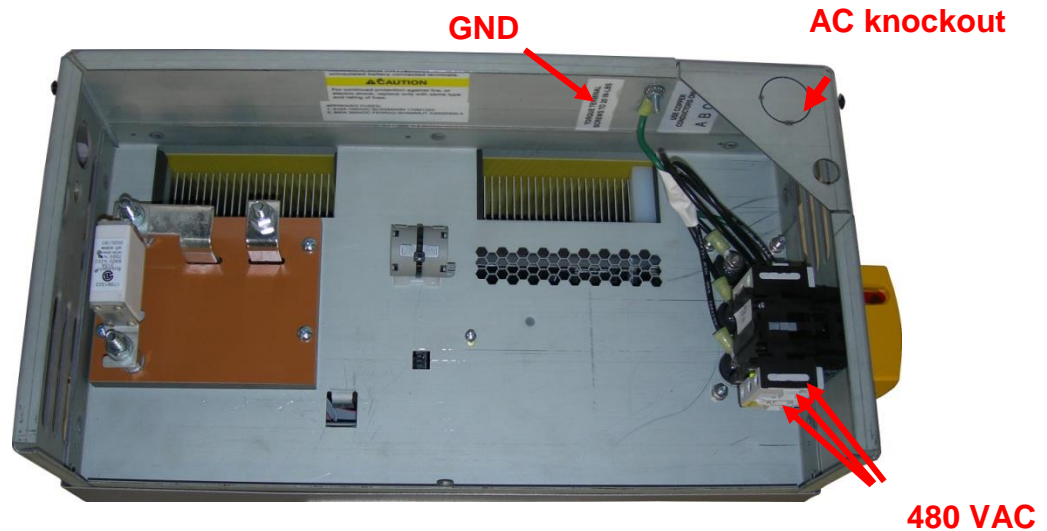
2. Verify that the source circuit is locked and tagged out before connecting power to the charger.
3. Verify that the AC disconnect switch on the charger is in the **OFF** position (Figure 12).





**Figure 12: AC disconnect switch**

4. Open the top of the charger by loosening the four mounting screws and lifting the cover off.
5. Push out the knockout (Figure 13) and pass the 480 VAC input power wires through, using the appropriate conduit or strain relief fittings per local and national codes.
6. Crimp a #10 ring tongue terminal (12-10 **American Wire Gauge (AWG)**) to the ground (**GND**) wire and connect it to the GND terminal (Figure 13). **Torque the nut to 20 in-lb.**
7. Strip the conductors back 0.5 inch (12 mm) and connect them to the disconnect switch where labeled 480 VAC 3Ø in Figure 13. **Torque the terminal screws to 20 in-lb. NOTE:** The charger is not phase-rotation sensitive.



**Figure 13: Charger electrical connection points**

8. Verify the line and ground connections of the outlet or junction box/disconnect.
9. With the charger switch **OFF**, energize the source circuit and verify proper AC voltage at the line side of the charger switch. All line-to-line voltages should be 400–480 VAC  $\pm$  10% and matched within 10 VAC. De-energize the source circuit.
10. Verify that the source circuit is locked and tagged out. Replace the top cover on the charger, securing it with the four mounting screws.

**THE CHARGER IS NOW READY FOR OPERATION**

# OPERATION PROCEDURE

## Charger Controls and User Interface

Users operate the **PowerCharge™ iHF3** series of chargers through each charger's front panel LCD/keypad (Figure 14).

This is the main user interface for viewing and displaying operation and fault messages. It also allows limited charger programming options. (For programming information, see CHARGER PROGRAMMING, page 42 of this manual.)



Figure 14: User interface LCD/keypad

# Getting Started

The LCD display on the **PowerCharge™ iHF3** series presents various screens and **SCREEN MESSAGES**.

## 1. Powering the Charger

- a. Energize the AC mains.
- b. Turn the AC disconnect switch to the **ON** position.
- c. Verify that the LCD display is lit and displays the **CONNECT BATTERY** screen. The LCD displays the battery voltage setting and the maximum current setting on the first line (e.g., 48 V and 200 A).

0	4	8		V														2	0	0		A
0	4	/	1	5	/	2	0	1	1				1	2	:	0	0	:	0	0		
			C	O	N	N	E	C	T				B	A	T	T	E	R	Y			
D	I	S	P	L	A	Y																

- d. If the LCD is not lit, or if the message is not displayed, cycle the switch to the **OFF** position and then return it to the **ON** position.



**DANGEROUS VOLTAGES AND CURRENTS ARE PRESENT IN THE AC MAINS WHEN ENERGIZED. ONLY TRAINED PERSONNEL SHOULD PERFORM THESE CHECKS, USING PROPER EQUIPMENT AND PROCEDURES.**

- e. If the charger still does not power up, carefully verify the source circuit and wiring to the charger and correct any problems. Check that the fuses in the AC mains junction box on the wall are intact, and that the supply voltage for all three phases (AC mains line-to-line) is 400 V–480 V  $\pm$  10%, and matches to 10 VAC or better.
- f. Restart the charger; if the problem persists, contact the dealer or Power Designers USA LLC.

## 2. Starting a Charge Cycle

- Connect the battery to the charger. Once the battery is detected, one of two messages appears on the LCD:

The LCD displays the **PUSH START TO BEGIN CYCLE** screen.

0	4	8		V													2	0	0		A
0	4	/	1	5	/	2	0	1	1					1	2	:	0	0	:	0	0
				P	U	S	H		S	T	A	R	T		T	0					
				B	E	G	I	N		C	Y	C	L	E							

If **Charge Autostart** is set to **YES**, the charger automatically starts the charge cycle, and briefly displays a **START CYCLE TIMER** message.

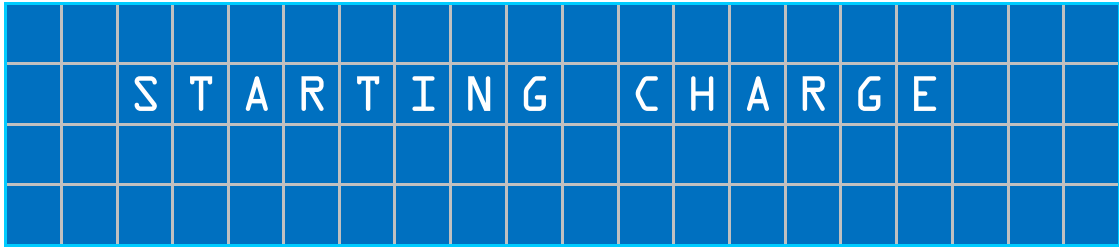
S	T	A	R	T		C	Y	C	L	E		T	I	M	E	R					
						0	0	:	0	0	:	0	1								
E	X	I	T														S	T	A	R	T

If either this screen or this message is not displayed, the battery has not been detected. Make sure that the battery cables are connected properly and verify that the auxiliary contacts are properly connected.

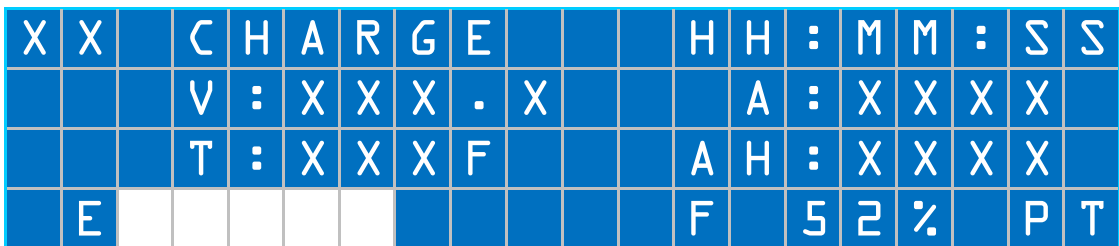
**NOTE:** If **Cells Autodetect** is set to **YES**, the LCD may display a **SELECT BATTERY VOLTAGE** message.

S	E	L	E	C	T		B	A	T	T	E	R	Y								
V	O	L	T	A	G	E															
								3	6		V										
E	X	I	T														E	N	T	E	R

- b. If the charger is not set to start automatically, start the charge cycle by selecting the **START** button on the keypad. A **STARTING CHARGE** screen appears for a few seconds.

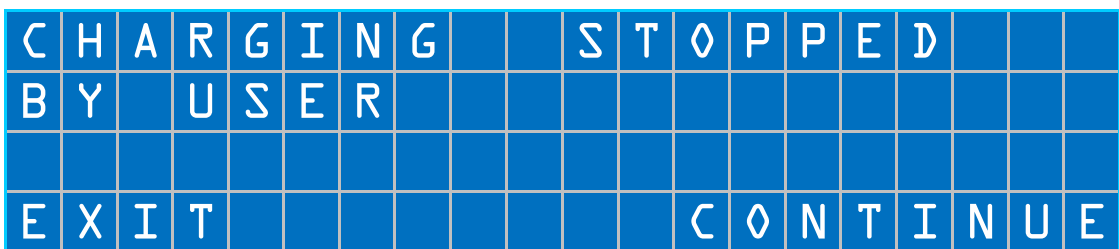


- c. The charge cycle begins and the following screen showing the charging operation display appears.



The **XX CHARGE** field in the upper left corner indicates the active charging mode, the **XX** replaced with **TR** for trickle, **CC** for constant current, **CV** for constant voltage, **FI** for finish, or **EQ** for equalize. The screen also displays a charge timer (upper right), battery voltage (**V**), amperes (**A**), temperature (**T**), and returned amp-hours (**AH**). The bottom of the screen displays the battery state of charge. If a **PowerTrac™ SP+** battery data logger is installed, **PT** is displayed in the lower right corner.

- d. To stop the charge cycle, select the **STOP** button. A **CHARGING STOPPED BY USER** screen appears.



Selecting **STOP** for the second time stops the charger completely and defaults to the **PUSH START TO BEGIN CYCLE** screen. Selecting **START** from the **CHARGING STOPPED BY USER** screen resumes the charge cycle and the screen will again display the charging operation display.

- e. Once the charge cycle has completed, the charger displays the **CYCLE COMPLETED** screen.

C	Y	C	L	E													H	H	:	M	M
C	O	M	P	L	E	T	E	D													
T	E	M	P	:	X	X	X	F			A	H	R	S	:	X	X	X	X		
E	X	I	T																		

On this screen appears the elapsed charging time, battery temperature, and total returned amp-hours.

## Charger Main Menu

From the charger **MAIN MENU** screen, access is provided to the following list of items:

- Charge History
- Charge Profiles
- Lifetime Summary
- Charger Model
- Recovery Cycle for Sulfated Battery
- Finish/Equalize Next Cycle
- Network Settings
- Language
- Run **PowerTrac™** Diagnostics

These screens may only be accessed when the charger is in idle mode (i.e., when either the **CONNECT BATTERY** or the **PUSH START TO BEGIN CYCLE** screens are displayed). Pushing the **Function** key (**F**) selects the charger **MAIN MENU** screens. The up/down arrow (**↑/↓**) keys scroll between the various screens.

In any **MAIN MENU** screen, selecting **EXIT (F)** returns to the **IDLE MODE** screen. Selecting the **F** key or the **ENTER** key (**ENT**) on any screen within the main menu returns to either the **IDLE MODE** screen or back to the previous screen.



## 1. Charge Cycle History

- a. With either **CONNECT BATTERY** or **PUSH START TO BEGIN CYCLE** displayed on the LCD, select **F**. The **CHARGE HISTORY** screen appears.

M	A	I	N		M	E	N	U	:												
					C	H	A	R	G	E		H	I	S	T	O	R	Y			
E	X	I	T														E	N	T	E	R

Selecting **EXIT** exits **MAIN MENU** and returns to the previous **IDLE MODE** screen; selecting **ENT** accesses the charge history for up to 200 charge cycles, beginning with the most recent cycle. Selecting **↑/↓** allows scrolling through the stored charge cycles, from the most recent cycle to the earliest (Cycle 0), in descending order.

C	H	↓	↑	↑		0	4	/	↓	↑	/	↓	↑		0	4	:	2	0			
V	0	L	T	:	5	8	.	6				H	R	S	:	0	3	:	2	↓		
T	E	M	P	:	9	8	F					A	H	R	S	:	↓	6	2			

This screen includes the following information:

<b>CH199</b>	Charge cycle number
<b>04/15/11</b>	Start date of charge cycle
<b>04:20</b>	Start time of charge cycle
<b>VOLT</b>	Battery end-of-charge voltage
<b>HRS</b>	Duration of charge cycle
<b>TEMP</b>	Maximum battery temperature recorded
<b>AHRS</b>	Amp-hours returned

- b. Selecting either of the left/right arrow (←/→) keys displays the second charger history screen.

C	H	1	9	9		0	4	/	1	5	/	1	1		0	4	:	2	0
A	C	T	I	V	A	T	E	D		P	R	O	F	I	L	E	S	:	
T	R		C	C		C	V		F	I		E	Q						
S	T	A	T	E	:	X	X	X	X	X	X	X	X	X	X	X	X	X	X

This second screen lists the following additional information for the selected charge cycle:

**ACTIVATED PROFILES** lists the profiles activated during the charge cycle. Trickle charge appears as **TR**, constant current as **CC**, constant voltage as **CV**, finish as **FI**, and equalize as **EQ**.

**STATE** indicates whether the cycle was completed successfully (**COMPLETED**), interrupted by the user (**STOPPED**), interrupted due to a power outage or disconnection (**TURNED OFF**), or interrupted due to a fault (e.g., **OV FAULT** for an overvoltage fault).

Selecting **F** returns to the **CHARGE HISTORY** screen.

Selecting **F** a second time returns to the **IDLE MODE** screen.

## 2. Charge Profiles

- a. While in **MAIN MENU**, select ↑/↓ until the **CHARGE PROFILES** screen appears.

M	A	I	N		M	E	N	U	:											
		C	H	A	R	G	E			P	R	O	F	I	L	E	S			
E	X	I	T													E	N	T	E	R

- b. Select **ENT** to access the selected screen and display the currently **ACTIVE PROFILE** along with the two programmed charger profiles.

A	C	T	I	V	E		P	R	O	F	I	L	E	:		P	0			
P	0	:	T	R		C	C		C	V										
P	1	:	T	R		C	C		C	V		F	I	E	Q					

This screen shows all of the programmed charge modes for Profile 0 and Profile 1. Refer to the **CHARGER PROGRAMMING** section, page 42 of this manual, for further details on programming these profiles.

## 3. Charger Lifetime Summary

- a. While in **MAIN MENU**, select ↑/↓ until the **LIFETIME SUMMARY** screen appears.

M	A	I	N		M	E	N	U	:											
		L	I	F	E	T	I	M	E		S	U	M	M	A	R	Y			
E	X	I	T													E	N	T	E	R

- b. Select **ENT** and a screen summarizing charger lifetime operation appears.

F	I	R	S	T		C	H	A	R	G	:	0	2	/	0	1	/	1	2
C	H	R	G		H	O	U	R	S	:	1	2	3	4					
A	M	P		H	O	U	R	S	:	1	2	3	4	5					
K	W		H	O	U	R	S	:	1	2	3	4							

This screen allows verification of charger usage: date of first charge, total charge hours, total amp-hours, and total kW since installation. This information may be used to compare usage on different chargers.

#### 4. Charger Model

- a. While in **MAIN MENU**, select **↑/↓** until the **CHARGER MODEL** screen appears.

M	A	I	N		M	E	N	U	:												
					C	H	A	R	G	E	R		M	O	D	E	L				
E	X	I	T														E	N	T	E	R

- b. Select **ENT** to access the selected screen, which lists the charger model number, manufacturing ID, manufacturing date, and firmware revision for reference.

M	O	D	E	L	:	P	C	i	H	F	1	0	k	W	-	4	8			
M	F	G		I	D	:	2	3	0	9	0	1	0	0	0	1				
M	F	G		D	A	T	E	:	0	1	/	0	1	/	2	0	0	9		
R	E	V	I	S	I	O	N	:	1	.	5	5								

## 5. Recovery Cycle for Sulfated Batteries

One of the unique features of this charger is the ability to run a safe, tailored recovery cycle for sulfated batteries. This can easily be done through the **RECOVERY CYCLE FOR SULFATED BATTERY** screen.

- a. Connect the battery to be recovered.

**NOTE: Do not attempt to recover a battery with a capacity of less than 250 amp-hours.**

- b. While in **MAIN MENU**, select **↑/↓** until the **RECOVERY CYCLE FOR SULFATED BATTERY** screen appears.

M	A	I	N		M	E	N	U	:											
	R	E	C	O	V	E	R	Y		C	Y	C	L	E		F	O	R		
		S	U	L	F	A	T	E	D		B	A	T	T	E	R	Y			
E	X	I	T													E	N	T	E	R

- c. Select **ENT** to access the recovery cycle set-up screens. The first screen selects the appropriate battery voltage.

		N	O	M	I	N	A	L		B	A	T	T	E	R	Y				
						V	O	L	T	A	G	E								
						4	8	V												
E	X	I	T													E	N	T	E	R

Selecting **↑/↓** toggles the battery voltage setting. Select the correct voltage and select **ENT**. The **RECOVERY CHARGE CURRENT** screen appears.

		R	E	C	O	V	E	R	Y		C	H	A	R	G	E				
						C	U	R	R	E	N	T								
						2	0	A												
E	X	I	T													E	N	T	E	R

Selecting **↑/↓** sets the recovery charge current setting in the range of 10 A to 60 A in 5 A increments. Recommended recovery charge current setting is 5 A/100 Ahrs (5% of rated capacity). **See Appendix D, page 66 of this manual, for instructions on how to determine the recovery charge current and timer setting.**

- d. Select the correct value, and then select **ENT**. The **RECOVERY CYCLE TIMER** screen appears.

		R	E	C	O	V	E	R	Y		C	Y	C	L	E					
							T	I	M	E	R									
							1	2	:	0	0									
E	X	I	T													E	N	T	E	R

Selecting **↑/↓** allows adjustment of the charge timer setting in 15-minute increments. The charge timer setting must be less than 24 hours. Select the desired value then select **ENT**. The **PUSH START TO BEGIN RECOVERY** screen appears.

						P	U	S	H		S	T	A	R	T					
		T	O			B	E	G	I	N		R	E	C	O	V	E	R	Y	
E	X	I	T																	

- e. Push **START** to initiate the recovery cycle. Once the cycle is complete, a **CYCLE COMPLETE** message appears.

**NOTE: The recovery cycle is a separate cycle; activating it does not affect other charger settings.**

## 6. Finish/Equalize Next Cycle

- a. While in **MAIN MENU**, select ↑/↓ until the **FINISH/EQUALIZE NEXT CYCLE** screen appears.

M	A	I	N		M	E	N	U	:												
	F	I	N	I	S	H		/		E	Q	U	A	L	I	Z	E				
				N	E	X	T			C	Y	C	L	E							
E	X	I	T														E	N	T	E	R

- b. Select **ENT** to access screen.

E	N	A	B	L	E		F	I	N	I	S	H		/		E	Q					
		Y	N			N	E	X	T		C	Y	C	L	E	:						
							N	Y														
E	X	I	T															E	N	T	E	R

- c. Select ↑/↓ to select **YES** or **NO**.

**NOTE:** Finish/equalization, once activated, remains active until an equalization cycle has completed.

## 7. Network Settings

**NOTE:** Network settings are retrievable through the Main Menu only for chargers that have the TCP/IP option.

- a. While in **MAIN MENU**, select ↑/↓ until the **NETWORK SETTINGS** screen appears.

M	A	I	N		M	E	N	U	:													
			N	E	T	W	O	R	K		S	E	T	T	I	N	G	S				
E	X	I	T															E	N	T	E	R

- b. Select **ENT** to view the network settings.

D	H	C	P	:	E	N	A	B	L	E			P	T	:	2	0	2	0
I	P	:	0	.	0	.	0	.	0										
M	A	S	K	:	2	5	5	.	2	5	5	.	2	5	5	.	2	5	5
G	W	:	0	.	0	.	0	.	0										

## 8. Language

- a. While in **MAIN MENU**, select **↑/↓** until the **LANGUAGE** screen appears.

M	A	I	N		M	E	N	U	:											
					L	A	N	G	U	A	G	E								
E	X	I	T													E	N	T	E	R

- b. Select **ENT** to access the next screen.

		S	E	L	E	C	T		L	A	N	G	U	A	G	E	:			
					E	N	G	L	I	S	H									
E	X	I	T													E	N	T	E	R

Selecting **↑/↓** toggles between language options (English or Japanese). Select **ENT** to implement the desired language option.



## 9. Run PowerTrac™ Diagnostics

**NOTE: The PowerTrac™ diagnostics option is only valid when connected to a battery with a PowerTrac™ SP+ battery monitoring system installed.**

- a. While in **MAIN MENU**, select ↑/↓ until the **RUN POWERTRAC DIAGNOSTICS** screen appears.

M	A	I	N		M	E	N	U	:												
			R	U	N		P	O	W	E	R	T	R	A	C						
			D	I	A	G	N	O	S	T	I	C	S								
E	X	I	T														E	N	T	E	R

- b. Select **ENT** to view the **PowerTrac™** diagnostic information.

I	O		E	X	P	A	N	D	E	R	:	Y	E	S							
T	E	M	P		A	D	C	:	4	0	9	5									
P	T		D	E	T	E	C	T	E	D	:	Y	E	S							
P	T		C	O	M	M	:	O	K	;	R	E	V		1	.	1	4			

The above display indicates diagnostics have passed. Except for the revision number, if any other data is displayed, please contact the dealer or Power Designers USA LLC for further assistance.

# TROUBLESHOOTING

Occasional faults may occur in certain conditions. Please follow the suggested steps.

## 1. Charger Does Not Power Up

When the charger is first turned on (main disconnect switch in the **ON** position), the LCD should come on and display one of the idle mode messages, typically the **CONNECT BATTERY** screen.

If the LCD is not illuminated after power is applied, perform the following checks:

- a. Verify that the main disconnect switch is in the **ON** position.
- b. Cycle the switch to the **OFF** position and then return it to the **ON** position.
- c. If the charger still does not power up, carefully verify the source circuit and wiring to the charger and correct any problems. Be sure to check that the fuses in the AC mains junction box on the wall are intact, and also that the supply voltage for all three phases (AC mains line-to-line) is 400–480 V  $\pm$  10%, and matches to 10 VAC or better.



**DANGEROUS VOLTAGES AND CURRENTS ARE PRESENT IN THE AC MAINS WHEN ENERGIZED. ONLY TRAINED PERSONNEL SHOULD PERFORM THESE CHECKS, USING PROPER EQUIPMENT AND PROCEDURES.**



**DO NOT ATTEMPT TO SERVICE THE CHARGER!**

## 2. Charger Fault During Operation

A fault message is displayed. **When contacting the dealer or Power Designers USA LLC, make sure to note the specific fault message that is displayed. This will aid in quick identification of the cause and the appropriate fix for the fault.**

### 3. AC Fault

A	C		F	A	U	L	T													
E	X	I	T																	

#### Possible Causes

- AC line voltage outside of allowable limits ( $\pm 10\%$ )
- Fuse blown
- Internal input stage failure

#### Troubleshooting

- a. Select **STOP** to revert to the **IDLE** screen.
- b. Verify the AC connections to the charger.
- c. Restart the charge cycle by selecting **START**.
- d. If the fault persists, contact the dealer or Power Designers USA LLC.

#### 4. Over Voltage or Over Current

O	V	E	R		C	U	R	R	E	N	T		F	A	U	L	T			
E	X	I	T																	

O	V	E	R		V	O	L	T	A	G	E		F	A	U	L	T			
E	X	I	T																	

##### Possible Causes

- Damaged DC (output) cables (open or short)
- Battery disconnected while charging (if thermistor disabled)

##### Troubleshooting

- a. The **OVER VOLTAGE FAULT** screen automatically reverts to the **IDLE MODE** screen in 30 seconds.
- b. Select **STOP** to revert to the **IDLE MODE** screen.
- c. Verify that the output cables are in good working condition and are properly connected to the battery.
- d. Restart the charge cycle by selecting **START**.
- e. If the fault persists, contact the dealer or Power Designers USA LLC.

## 5. Over Temperature Ambient

C	H	A	R	G	E	R		S	T	O	P	P	E	D	:				
A	M	B	I	E	N	T													
O	V	E	R		T	E	M	P	E	R	A	T	U	R	E				
E	X	I	T																

### Possible Causes

- Dirty air filter
- Blocked air flow to the charger
- Failed cooling fan
- Room temperature above 104°F

### Troubleshooting

- Select **STOP** to revert to the **IDLE MODE** screen.
- Allow the charger to cool down.
- Make sure there are no airflow restrictions at the front or the rear of the charger chassis.
- Check the air filter and clean if necessary.
- Restart the charge cycle by selecting **START**.
- If the fault persists, contact the dealer or Power Designers USA LLC.

## 6. General Fault

G	E	N	E	R	A	L		F	A	U	L	T							
E	X	I	T																

### Possible Causes

- A primary over current fault produces this message with earlier versions of the firmware

### Troubleshooting

- a. Select **STOP** to revert to the **IDLE MODE** screen.
- b. Restart the charge cycle by selecting **START**.
- c. If the fault persists, contact the dealer or Power Designers USA LLC.

## 7. Battery Disconnected Fault

C	H	A	R	G	E	R		S	T	O	P	P	E	D	:				
B	A	T	T	E	R	Y													
D	I	S	C	O	N	N	E	C	T	E	D								
E	X	I	T																

### Possible Causes:

- Battery cable was disconnected while the charge cycle was active
- The charger or battery cables are damaged
- The charger or battery connectors' contacts are dirty or corroded

### Troubleshooting:

- a. If the battery was intentionally disconnected, select **STOP** to clear the fault message.
- b. If the battery was not intentionally disconnected, check the charger and battery cables, as well as the charger and battery connectors' contacts. Fix, clean, or replace damaged or dirty contacts or cables.
- c. Select **STOP** to clear the fault message.
- d. Restart the charge cycle by selecting **START**.
- e. If the fault persists, contact the dealer or Power Designers USA LLC.

## 8. Battery Fault: Over Temperature

C	H	A	R	G	E	R		S	T	O	P	P	E	D	:				
B	A	T	T	E	R	Y													
O	V	E	R		T	E	M	P	E	R	A	T	U	R	E				
E	X	I	T																

### Possible Causes

- Battery temperature exceeded preset limit
- Faulty thermistor
- Faulty **PowerTrac™**

### Troubleshooting

- a. The charge cycle remains stopped until the battery has cooled down by 6°C (10.8°F). The charger automatically restarts the cycle.
- b. If the over temperature fault occurs again, the charge cycle remains stopped until the battery has cooled down by 7°C (12.6°F), and then automatically restarts the cycle.
- c. The charger repeats this sequence for up to three additional attempts to restart and complete the cycle, allowing the battery to cool down by 8°C (14.4°F), 9°C (16.2°F), and 10°C (18.0°F) for subsequent attempts.
- d. If the charger is unable to restart and complete the charge cycle successfully, select **STOP** to revert to the **IDLE MODE** screen.
- e. Attempt to measure the battery case temperature. If the battery case temperature is NOT elevated, verify that the battery cables are properly connected, paying special attention to the thermistor connections.
- f. Restart the charge cycle by selecting **START**.



- g. If an elevated battery temperature is detected, do not restart the charge cycle, or if the fault persists, contact the dealer or Power Designers USA LLC.



## 9. Charger Timeout Faults

C	H	A	R	G	E	R		T	I	M	E	◊	U	T	:				
X	X	X	X	X	X	X	X	X	X	X	X		T	I	M	E	R		
E	X	I	T																

The **XXXXXXXX** field indicates which timer has caused the problem: **TOTAL CHARGE**, **TRICKLE CHARGE**, **CC CHARGE**, **CV CHARGE**, or **FINISH CHARGE TIMER**.

### Possible Causes

- Programmed charge timers are set incorrectly
- Programmed charge parameters are set incorrectly
- Battery has shorted cell(s)

### Troubleshooting

- a. Select **STOP** to revert to the **IDLE MODE** screen.
- b. Start the **PowerCharge User** software provided for use with Palm, Pocket PC, PC, or Netbook, select the **Charge Timers** button and select the **Scan** button on the **CHARGE TIMERS** screen.
- c. Verify that the programmed timer values are correct. If not, reset as appropriate.
- d. Using the provided software, start the **PowerCharge User** program, select **Charge Parameters** and then select the **Scan** button on the **CHARGE PARAMETERS** screen.
- e. Verify that the programmed parameters values are correct. If not, reset as appropriate.
- f. Verify that the battery is in good working condition (i.e., no shorted cells).
- g. If the fault persists, contact the dealer or Power Designers USA LLC.

## **RETURN MATERIAL PROCESS**

In the event that the troubleshooting steps included in this manual do not resolve the problem,

- a. Record the charger serial number and drawer or part serial number;
- b. Call Power Designers USA LLC with a description of the problem.

Power Designers USA LLC will attempt to resolve the problem over the phone. If the issue cannot be resolved in this manner, a Return Material Authorization (RMA) form must be completed and submitted to Power Designers USA LLC.

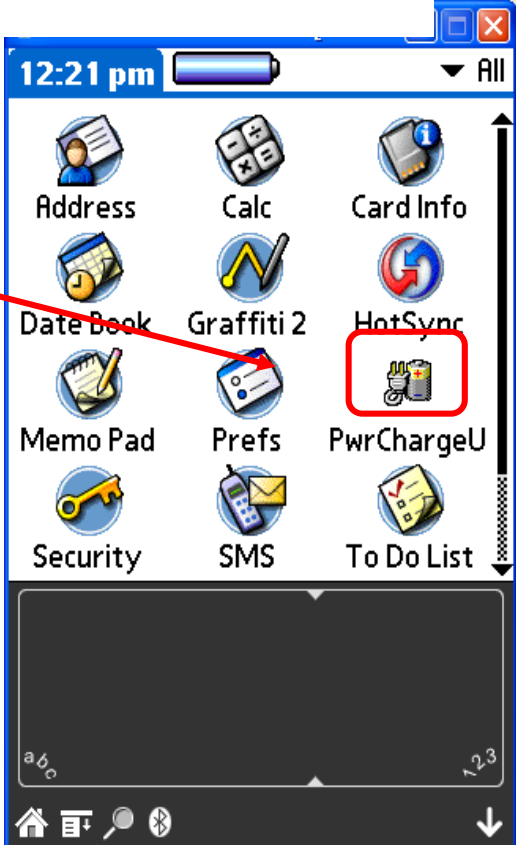
Upon receipt of the completed RMA form, Power Designers USA LLC will issue an RMA number for the return. Based on the serial number of the specific charger(s) and the particular problem encountered, Power Designers USA LLC will either repair or replace the defective components under warranty.

For chargers out of warranty, Power Designers USA LLC, upon receipt of the charger and in consideration of a diagnostic fee, will provide a repair estimate.

# CHARGER PROGRAMMING

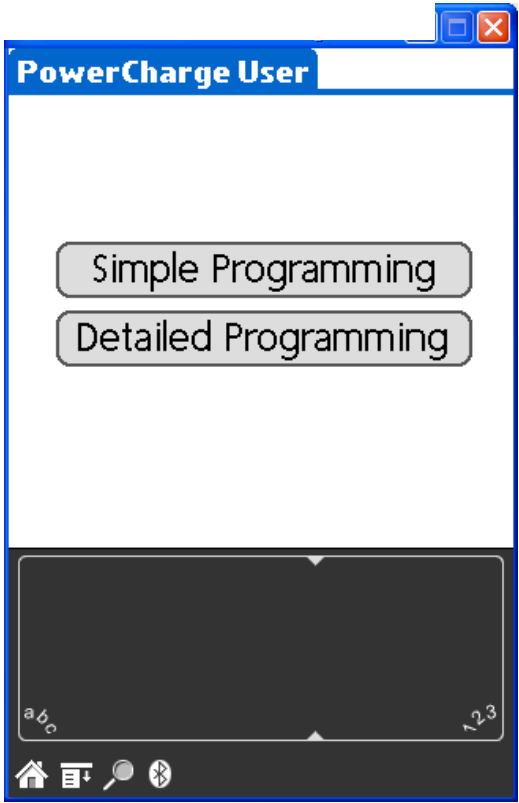
Each charger ships preconfigured for the application. To change this programming, please follow these procedures.

**NOTE:** Screens shown are typical of the Palm PDA application. Similarly organized screens, with the same functionality, are found on the Pocket PC and desktop applications.

<p>To use the PowerCharge Palm software to program the charger, go to the Palm Home/desktop and select the <b>PwrChargeU</b> icon on the Palm desktop. <b>NOTE:</b> This icon appears as <b>Start PowerChargeUser</b> on the Pocket PC, and <b>PowerChargeUser</b> on the desktop.</p>	 <p>The screenshot shows a Palm PDA desktop interface. At the top, the time is 12:21 pm and there is a battery status indicator. Below the status bar is a grid of application icons. The icons include Address, Calc, Card Info, Date Book, Graffiti 2, HotSync, Memo Pad, Prefs, PwrChargeU, Security, SMS, and To Do List. The PwrChargeU icon, which depicts a battery and a plug, is highlighted with a red rectangular box. A red arrow originates from the text in the left column and points directly to this icon. At the bottom of the screen, there is a keyboard area with 'a b c' and '1 2 3' indicators, and a dock with icons for home, search, and power.</p>
--	--

Two Programming Modes are available:

- **Simple Programming** can be used to quickly set the basic charge parameters and timers based on the battery voltage and capacity.
- **Detailed Programming** allows full use of the charger’s capabilities by manually programming any of the charger settings, parameters, and timers.



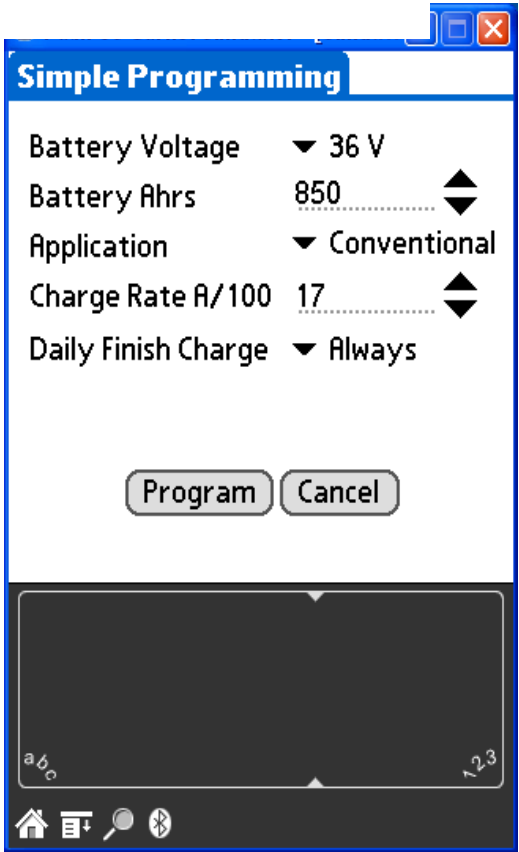
The screenshot shows a window titled "PowerCharge User" with a white background. Two large, rounded rectangular buttons are centered on the screen: "Simple Programming" (top) and "Detailed Programming" (bottom). Below the buttons is a dark grey area representing a keyboard, with "abc" on the left and "123" on the right. At the bottom of the keyboard area are icons for home, list, search, and Bluetooth.

**Simple Programming Screen**

The **SIMPLE PROGRAMMING** screen offers the following functions.

Programming Options	Programming Function
Battery Voltage	Select the appropriate battery voltage.
Battery Ahrs	Input battery capacity in Ahrs, in increments of 10 Ahrs.
Application	Select <b>Conventional</b> to set automatically for charging at 17% of rated capacity (17 A/100 Ahrs), <b>Opportunity</b> for 25% of rated capacity (25 A/100 Ahrs, or <b>Fast Charge</b> for 40% of rated capacity (40 A/100 Ahrs).
Charge Rate	Allows adjustment of the preset charge rate in amps/100 Ahr of battery capacity, in increments of 1 A up to 60 A maximum.
Daily Finish Charge	If <b>Opportunity</b> or <b>Conventional</b> charging is selected, Daily Finish Charge is <b>Always</b> . For <b>Fast</b> charging, it is <b>None</b> . Selecting <b>Custom</b> will allow the user to make adjustments via the <b>Detailed Programming</b> screens.

- The **Simple Programming** screen contains five programming options.
- Select the appropriate arrow button to access the desired pull-down menu or type in the appropriate value.



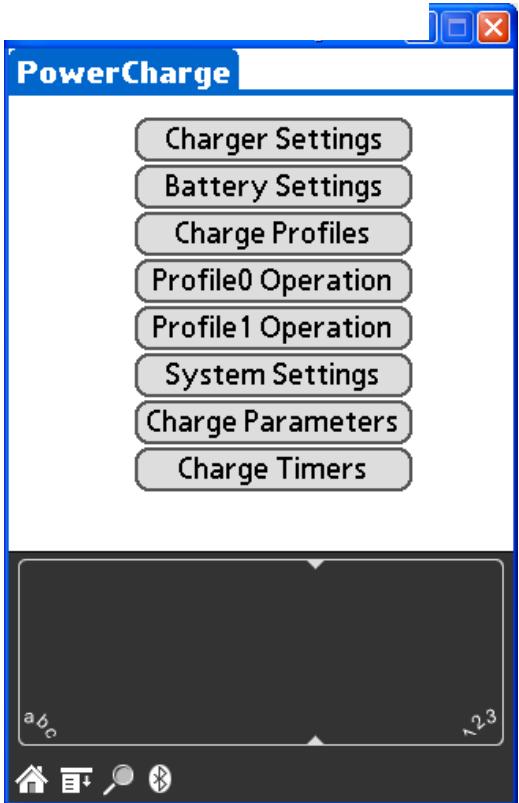
The screenshot shows a window titled "Simple Programming" with a blue header. It contains five settings, each with a pull-down arrow on the right: "Battery Voltage" set to 36 V, "Battery Ahrs" set to 850, "Application" set to Conventional, "Charge Rate A/100" set to 17, and "Daily Finish Charge" set to Always. Below the settings are two buttons: "Program" and "Cancel". At the bottom of the window is a dark area with a keyboard layout showing "a b c" and "1 2 3". A system tray at the very bottom contains icons for home, list, search, and Bluetooth.

### Detailed Programming Screen

The **DETAILED PROGRAMMING** screen offers the following functions.

Screen Name	Programming Function
Charger Settings	Scan charger factory-set designations and ratings.
Battery Settings	Scan and set battery parameters.
Charger Profiles	Scan and set charging profiles.
Profile 0 Operation	Scan and set a custom finish charge operation.
Profile 1 Operation	Scan and set the equalization charge operation.
System Settings	Scan and set charger system options.
Charger Parameters	Scan and set the charging current and voltage parameters.
Charger Timers	Scan and set the charging timers.

- The **Detailed Programming** screen contains buttons for nine programming screens.
- Select the appropriate button to access the desired programming screen.



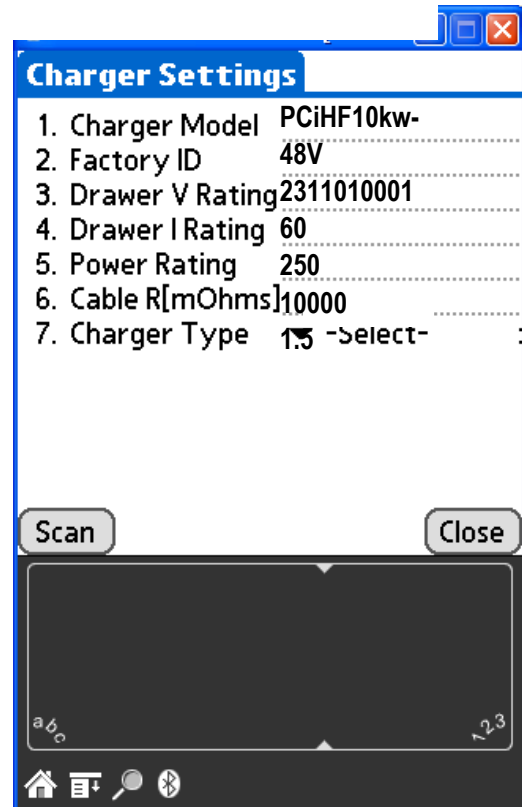
The screenshot shows a window titled "PowerCharge" with a list of nine buttons: "Charger Settings", "Battery Settings", "Charge Profiles", "Profile0 Operation", "Profile1 Operation", "System Settings", "Charge Parameters", and "Charge Timers". At the bottom of the window, there is a dark area with "abc" on the left and "123" on the right, and a dock with icons for home, list, search, and Bluetooth.

### Charger Settings Screen

The **CHARGER SETTINGS** screen displays the following charger parameters. These parameters are not field-programmable.

	Parameter	Description
1	Charger Model	Charger model number.
2	Factory ID	Factory-programmed serial number.
3	Voltage Rating	Factory-programmed voltage rating.
4	Current Rating	Factory-programmed current rating.
5	Power Rating	Factory-programmed power rating.
6	Cable R [mOhms]	Charger cable resistance, used to correct for cable voltage drop.
7	Charger Type	Parallel or stand-alone.

- ❑ To view Charger Settings:
  - On the Palm desktop, select the **PwrChargeU** icon.  
**NOTE:** This icon appears as **Start PowerChargeUser** on the Pocket PC, and **PowerChargeUser** on the desktop.
  - Select the **Detailed Programming** button and then the **Charger Settings** button.
  - Align the Palm with the IR window on the LCD/keypad.
  - Select the **Scan** button to view the charger settings.



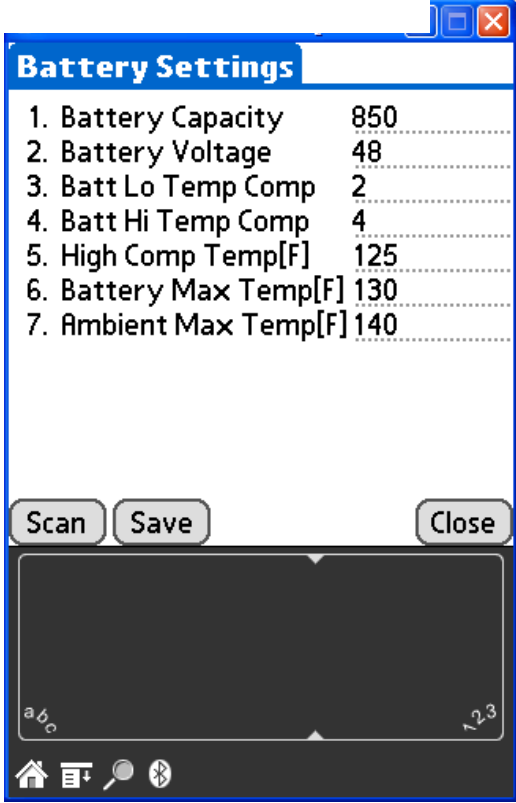
## **Battery Settings Screen**

The **BATTERY SETTINGS** screen is used to view and/or modify battery parameters. Battery voltages are expressed in **Volts Per Cell (VPC)**.

	<b>Parameter</b>	<b>Description</b>	<b>Defaults</b>
1	Battery Capacity	Nominal battery capacity in Ahrs. This value is used to limit some of the programmed current settings to safe limits. Range: 100–1999 Ahrs	850 Ahrs
2	Battery Voltage	Nominal charger output voltage Range: 12–80 V	48 V
3	Batt Low Temp Comp <b>NOTE</b>	The battery low temperature compensation coefficient in mV/°C/VPC. This is activated if the battery temperature is different than 77°F but lower than the High Comp Temp limit. Range: 0–10 mV/°C/VPC	2 mV/°C/VPC
4	Batt High Temp Comp <b>NOTE</b>	The battery high temperature compensation coefficient in mV/°C/VPC. This is activated if the battery temperature exceeds the High Comp Temp limit. Range: 0–10 mV/°C/VPC	4 mV/°C/VPC
5	High Comp Temp [F]	The temperature at which the high temperature compensation is activated. Range: 32–165°F	125°F
6	Battery Max Temp [F]	Maximum allowable battery temperature. A charger fault is generated if the battery temperature exceeds this limit. Range: 32–165°F	130°F
7	Ambient Max Temp [F]	Maximum allowable ambient temperature. A charger fault is generated if the ambient temperature exceeds this limit. Range: 32–160°F	140°F

**NOTE:** Temperature compensation is critical to maintaining battery life and performance. A maximum battery temperature > 140°F is rare, and will shorten the battery life. **Increasing the value of any of the compensation values is rarely necessary. See Appendix E, page 67 of this manual, for a discussion of temperature compensation.** Consult Power Designers USA LLC if you have questions.



<ul style="list-style-type: none"> <li>❑ To view Battery Settings: <ul style="list-style-type: none"> <li>➤ On the Palm desktop, select the <b>PwrChargeU</b> icon. <b>NOTE:</b> This icon appears as <b>Start PowerChargeUser</b> on the Pocket PC, and <b>PowerChargeUser</b> on the desktop.</li> <li>➤ Select the <b>Detailed Programming</b> button and then the <b>Battery Settings</b> button.</li> <li>➤ Align the Palm with the IR window on the LCD/keypad.</li> <li>➤ Select the <b>Scan</b> button to view the programmed values.</li> </ul> </li> <li>❑ To change Battery Settings: <ul style="list-style-type: none"> <li>➤ Type the desired values into the respective fields.</li> <li>➤ Align the Palm with the IR window on the LCD/keypad.</li> <li>➤ Select the <b>Save</b> button to apply the new settings. <b>NOTE:</b> Keep the Palm aligned until a confirmation screen appears.</li> </ul> </li> </ul>	
--	---

**Charge Profiles Screen**

The **CHARGE PROFILES** screen is used to view and program the charging modes for the two charging profiles:

- a. Profile 0: The default daily profile. The default settings are **Trickle** and **CV Mode**.
- b. Profile 1: A periodic profile that can be activated for battery equalization.

The following table describes charging modes.

Parameter	Description
Trickle	The <b>Trickle</b> charge is a low current charging mode used to recover sulfated or deeply discharged batteries.
CV Mode	The <b>CV Mode</b> is a constant voltage charging mode that sets the maximum charging voltage during CV operation.
Finish	<b>Finish</b> activates a finish charge cycle to top off the battery.
Equalize	<b>Equalize</b> activates an equalization charge cycle.

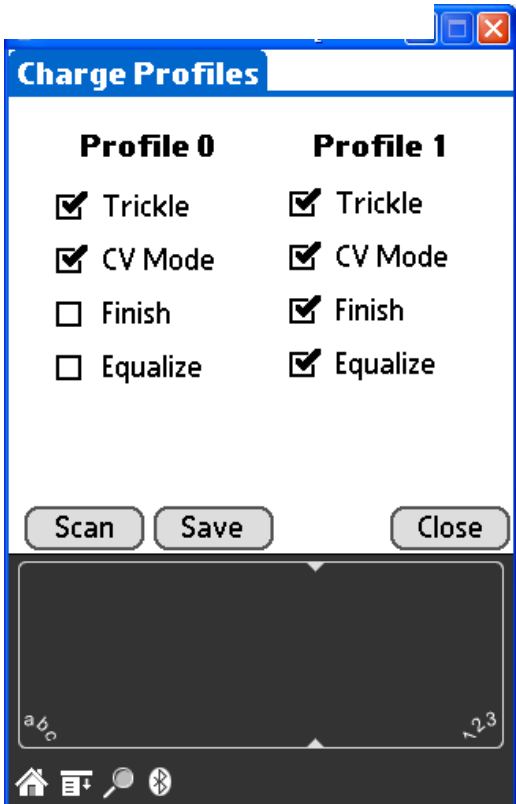
<ul style="list-style-type: none"> <li>❑ To view Charge Profile settings: <ul style="list-style-type: none"> <li>➤ On the Palm desktop, select the <b>PwrChargeU</b> icon. <b>NOTE:</b> This icon appears as <b>Start PowerChargeUser</b> on the Pocket PC, and <b>PowerChargeUser</b> on the desktop.</li> <li>➤ Select the <b>Detailed Programming</b> button and then the <b>Charge Profiles</b> button.</li> <li>➤ Align the Palm with the IR port on the LCD/keypad.</li> <li>➤ Select the <b>Scan</b> button to view the programmed values.</li> </ul> </li> <li>❑ To activate/deactivate charge modes: <ul style="list-style-type: none"> <li>➤ Check the respective boxes to select/deselect the desired charge modes.</li> <li>➤ Align the Palm with the IR port on the LCD/keypad</li> <li>➤ Select the <b>Save</b> button to apply the new settings. <b>NOTE:</b> Keep the Palm aligned until a confirmation screen appears.</li> </ul> </li> </ul>	
--	---

Figure 14 illustrates the various charge modes for a typical charge cycle.

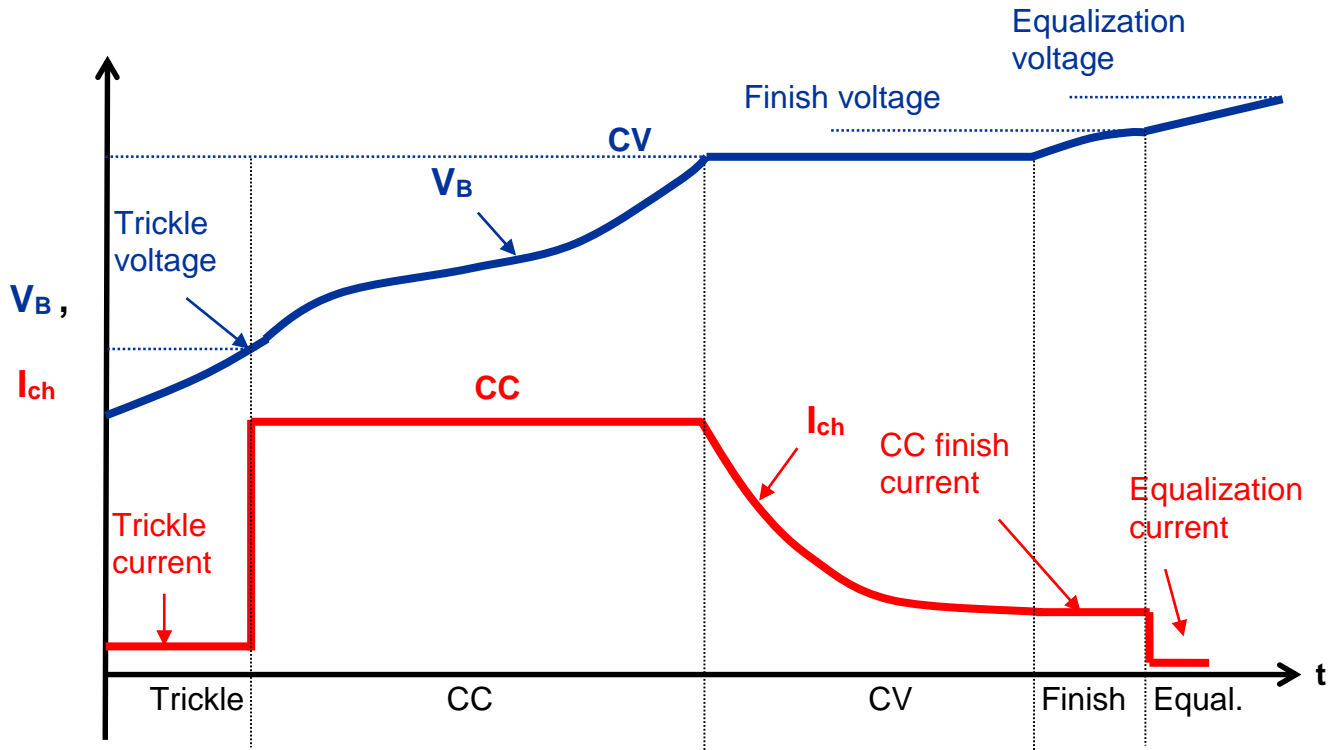


Figure 14: Typical charge cycle – charge modes

## Profile 0 Operation

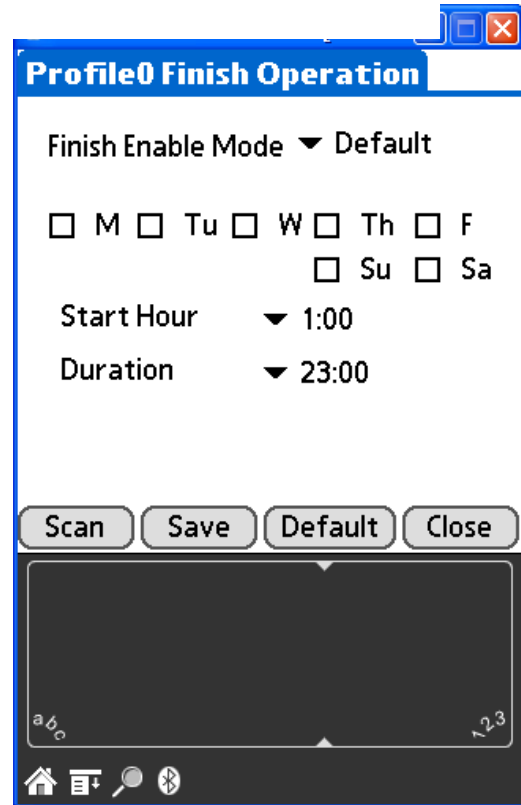
The **PROFILE 0 OPERATION** screen is used to view and program the finish charge operation in Profile 0. The finish mode must be selected on the **CHARGE PROFILES** screen to be able to select the **Custom** option.

In **Default**, the finish charge mode is part of every charge cycle. **Custom** allows complete adjustment of days of the week, start hour, and duration for a finish charge cycle. The default start time is 1:00 (1:00 am) and the default duration is 22:00 hours. (**NOTE:** All times are 24-hour clock times.)

- To view or program a Profile 0 Custom Finish charge operation:

On the Palm desktop, select the **PwrChargeU** icon.  
**NOTE:** This icon appears as **Start PowerChargeUser** on the Pocket PC, and **PowerChargeUser** on the desktop.

- Select the **Detailed Programming** button and then the **Profile0 Operation** button.
- Align the Palm with the IR port on the LCD/keypad.
- Select the **Scan** button to view the programmed values.
- Change the desired parameters, then select the **Save** button to apply the new settings. **NOTE:** Keep the Palm aligned until a confirmation screen appears.



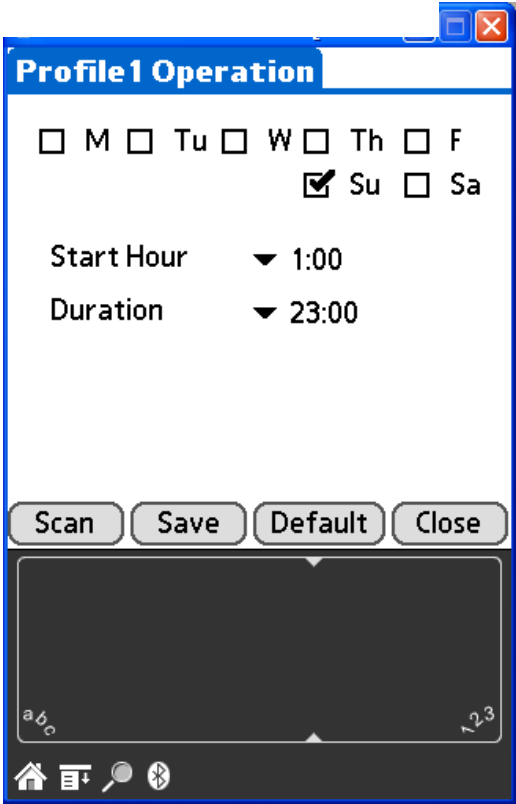
## Profile 1 Operation

The **PROFILE 1 OPERATION** screen is used to view and program the Profile 1 settings. When this profile is active, days of the week, start hour, and duration are selected.

Profile 1 is typically set to run on weekends when finish and equalize charging can be conveniently implemented. Default values are Sunday, with a start time of 1:00 (1:00 am) and duration of 22:00 hours. (**NOTE:** All times are 24-hour clock times.)

When the selected day and start hour are reached, the charger will invoke Profile 1. When the duration times out, the charger will return to the default profile.

**NOTE:** In order for the charger to automatically switch between profiles, the **Profile Auto Switch** setting must be enabled (see **System Settings Screens**, page 53).

<ul style="list-style-type: none"><li><input type="checkbox"/> To view or program Profile 1 settings:<ul style="list-style-type: none"><li>➤ On the Palm desktop, select the <b>PwrChargeU</b> icon. <b>NOTE:</b> This icon appears as <b>Start PowerChargeUser</b> on the Pocket PC, and <b>PowerChargeUser</b> on the desktop.</li><li>➤ Select the <b>Detailed Programming</b> button and then the <b>Profile1 Operation</b> button.</li><li>➤ Align the Palm with the IR port on the LCD/keypad.</li><li>➤ Select the <b>Scan</b> button to view the programmed values.</li><li>➤ Change parameters, then select the <b>Save</b> button to program new settings. <b>NOTE:</b> Keep the Palm aligned until a confirmation screen appears.</li></ul></li></ul>	
--	---

## System Settings Screens

**SYSTEM SETTINGS** screens are used to view and modify various charger options and system parameters.

	Parameter	Description	Defaults
First screen			
1	Present Date	Today's date.	Manuf. date
2	Present Time	Present time.	CST
3	Cells Autodetect	Autodetect battery nominal voltage (# of cells)—YES or NO. If NO is selected, the charger is set for single voltage operation.	YES
4	Charge Autostart	Autostart charger upon connecting a battery—YES or NO.	NO
5	Temp Format	Temperature display—°C or °F.	Fahrenheit
6	Daylight Savings	Automatically adjust for daylight time saving—YES or NO.	YES
7	Active Profile	Default profile to be activated—Profile 0 or Profile 1.	Profile 0
8	Profile Autoswitch	Automatically switch between Profile 0 and Profile 1 once the start day and time of Profile 1 are reached—YES or NO.	YES
Second screen			
1	Precharge High	The high voltage limit of the precharge function. Range: 12.0–60.0 V	50V
2	Precharge Low	The low voltage limit of the precharge function. Range: 12.0–60.0 V	40V
3	Precharge Idle	Precharge is enabled—YES or NO.	NO
4	Equalize Mode	Termination condition for the equalization charge phase—Timer Limit or CV Limit.	Timer Limit
5	Use PT Params	Using the <b>PowerTrac™SP+</b> with 485 Comm—YES or NO.	No
6	Ignore PT Faults	Prevent the <b>PowerTrac™SP+</b> from disabling the charger on a <b>PowerTrac™</b> fault—YES or NO.	No
7	Delay Start Timer	Set time delay to start charger after battery cooldown.	0 min

**Notes:**

1. Power Designers USA LLC recommends that the default values not be changed.
2. The **Precharge High/Low** voltage limits function is an optional feature that, if enabled, maintains the charger output voltage between the precharge low and precharge high voltage limits. This eliminates any inrush current or sparking that can result when connecting a battery to the charger. The inrush current is caused by the rapid charging of the output filter capacitor upon connection to a battery.
3. **Use PT Params** should be selected (YES) when charging batteries equipped with the **PowerTrac™** monitor and when charging batteries of different voltages or amp-hour capacities using the same charger.
4. The **Delay Start Timer** is used in conventional charging to allow battery cool down prior to starting a charge cycle. Enter the desired time delay in minutes. Default is 0 minutes.
5. **Additional Power Limit** and **Time of Day** functions are available to reduce energy usage and costs by setting the charger to operate only after the local utility's peak demand period, thus avoiding or minimizing peak demand charges. Contact Power Designers USA LLC for details.

- ❑ There are two **System Settings** screens used to view/program system parameters and various charger options.

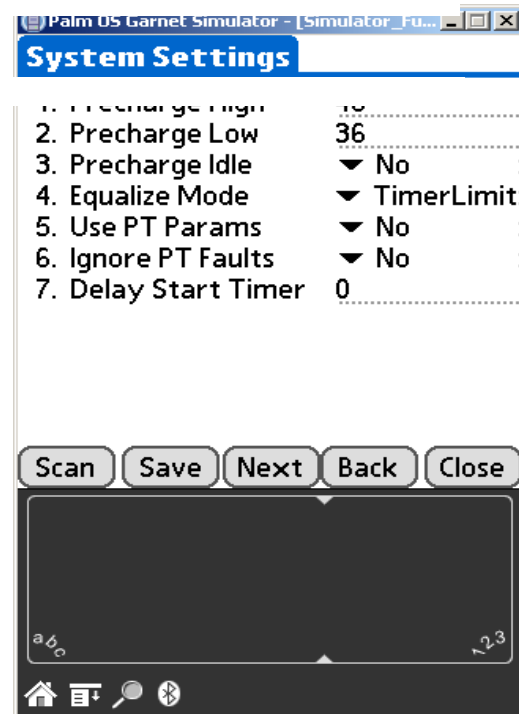
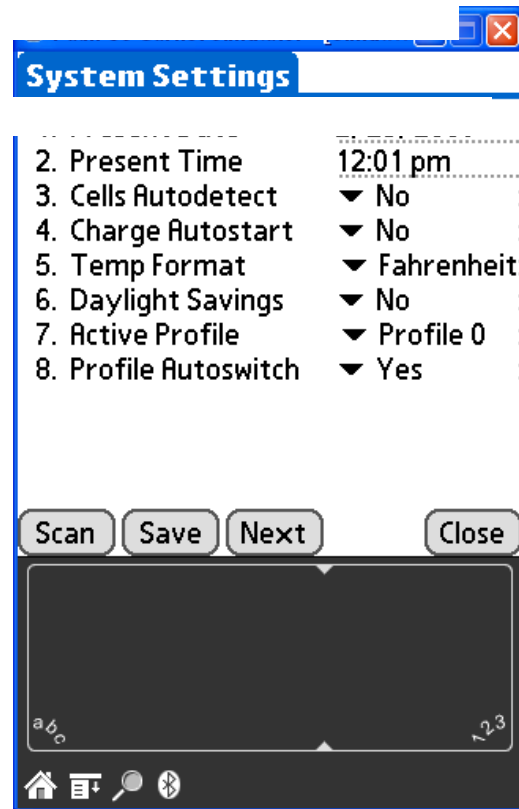
- ❑ To view System Settings:
  - On the Palm desktop, select the **PwrChargeU** icon.  
**NOTE:** This icon appears as **Start PowerChargeUser** on the Pocket PC, and **PowerChargeUser** on the desktop.

- Select the **Detailed Programming** button and then the **System Settings** button.
- Align the Palm with the IR port on the LCD/keypad.
- Select the **Scan** button to view the programmed values.
- Select the **Next** button to go to the second screen; select **Back** to return to the first screen.

- ❑ To program System Settings:

- Select/type in desired settings in the respective fields.
- Align the Palm with the IR port on the LCD/Keypad.
- Select the **Save** button to program new settings.  
**NOTE:** Keep the Palm aligned until a confirmation screen appears.

- ❑ **System Settings - Second Screen**



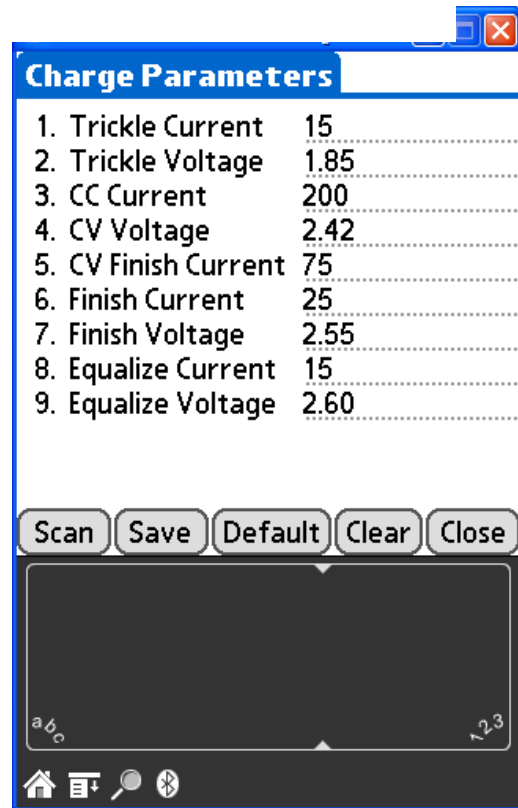


### **Charge Parameters Screen**

The **CHARGE PARAMETERS** screen is used to view and modify the current and voltage settings for the charger. The following table shows typical values for a 500 Ahr fast charge battery.

	<b>Parameter</b>	<b>Recommended Value</b>	<b>Example</b>
1	Trickle Current	~3 A /100 Ahrs (Range: 1–600 A)	15 A
2	Trickle Voltage	1.75–1.95 VPC (Range: 1.80–2.10 V)	1.85 VPC
3	CC Current	40–50 A /100 Ahrs (Range: 1–600 A)	200 A
4	CV Voltage	2.37–2.45 VPC (Range: 2.00–2.60 V)	2.42 VPC
5	CV Finish Current	12–15 A /100 Ahrs (Range: 1–600 A)	75 A
6	Finish Current	~5 A /100 Ahrs (Range: 1–600 A)	25 A
7	Finish Voltage	2.55–2.60 VPC (Range: 2.00–2.70 V)	2.55 VPC
8	Equalize Current	~3 A /100 Ahrs (Range: 1–600 A)	15 A
9	Equalize Voltage	2.60 VPC (Range: 2.00–2.70 VPC)	2.60 VPC

- ❑ To view Charge Parameters:
  - On the Palm desktop, select the **PwrChargeU** icon.  
**NOTE:** This icon appears as **Start PowerChargeUser** on the Pocket PC, and **PowerChargeUser** on the desktop.
  - Select the **Detailed Programming** button and then the **Charge Parameters** button.
  - Align the Palm with the IR port on the LCD/keypad.
  - Select the **Scan** button to view the programmed values.
- ❑ To program Charge Parameters:
  - Type in desired settings in the respective fields.
  - Align the Palm with the IR port on the LCD/keypad.
  - Select the **Save** button to program new values. **NOTE:** Keep the Palm aligned until a confirmation screen appears.



## Charge Timers Screen

The **CHARGE TIMERS** screen is used to view and modify the timers for each charge mode.

	Parameter	Description	Defaults
1	Total Timer	The total timer sets the maximum duration of a charge cycle. Range: 0–12:00 hrs	9:00 hrs
2	Trickle Timer	The trickle timer sets the maximum duration of a trickle charge phase. This timer is <b>not</b> included in the total timer duration. Range: 0–12:00 hrs	12:00 hrs
3	CC Charge Timer	The constant current timer sets the maximum duration of a constant current charge phase. Range: 0–12:00 hrs	3:00 hrs
4	CV Charge Timer	The constant voltage timer sets the maximum duration of a constant voltage charge phase. Range: 0–12:00 hrs	3:00 hrs
5	Finish dV	Sets dV in mV/cell for the finish termination condition. If the VPC does not change by this amount in the specified dt time, the finish mode will be terminated. Range: 1–200 mV	5 mV/cell
6	Finish dt	Sets dt in minutes for the finish termination condition. Range: 1–120 min	25 min
7	Finish Timer	The finish charge timer sets the maximum duration of a finish charge phase. Range: 0–12:00 hrs	3:00 hrs
8	Equalize Timer	The equalize timer sets the maximum duration of an equalize charge phase. This is <b>not</b> included in the total timer duration. Range: 0–12:00 hrs	6:00 hrs
9	High Pulse Time	<b>DO NOT CHANGE DEFAULT VALUE!</b>	60 sec
10	Zero Pulse Time	<b>DO NOT CHANGE DEFAULT VALUE!</b>	1 sec

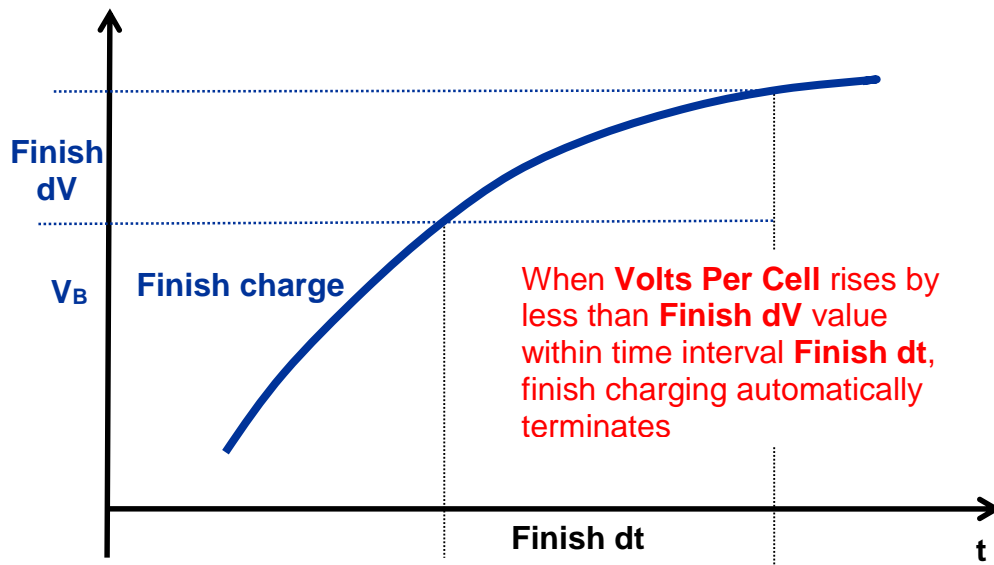
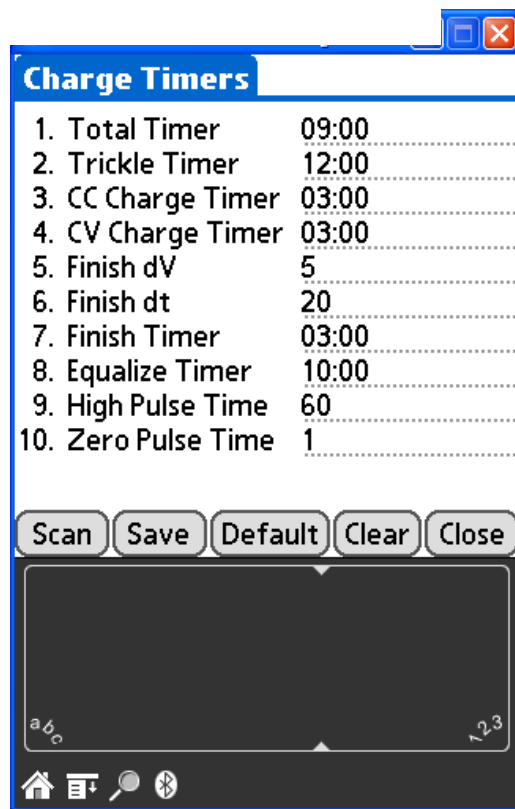


Figure 15: Finish charge termination criteria

- ❑ To view Timers settings:
  - On the Palm desktop, select the **PwrChargeU** icon. **NOTE:** This icon appears as **Start PowerChargeUser** on the Pocket PC, and **PowerChargeUser** on the desktop.
  - Select the **Detailed Programming** button and then the **Charge Timers** button.
  - Align the Palm with the IR port on the LCD/keypad.
  - Select the **Scan** button to view the programmed values.
- ❑ To program Timers:
  - Type in desired durations in the respective fields.
  - Align the Palm with the IR port on the LCD/keypad.
  - Select the **Save** button to program new values. **NOTE:** Keep the Palm aligned until a confirmation screen appears.



**Limited Warranty**  
**MODEL PowerCharge XP, PowerCharge iHF, REVOLUTION SERIES**  
**FOR INDUSTRIAL APPLICATIONS USED IN THE USA & CANADA**

Power Designers USA LLC (“PD”) hereby warrants each new *PowerCharge XP, PowerCharge iHF and REVOLUTION Series* battery charger (the “Product”) for industrial application shipped after April 1, 2014 pursuant to the following terms and conditions (the “Product” Limited Warranty):

1. Subject to the provisions below, PD warrants the Product against defective materials and workmanship for a period of two (2) years from date of shipment (the “Warranty Period”).
  - a. On-Site Service during the first year of the term of this limited warranty period. The company will compensate or provide on-site service during the first year of the limited warranty term. If it is believed there is a defect in the Product, Authorized service can be requested by contacting the PD Service Group at 608-216-9295. If, during the first year of limited warranty period, PD determines on-site limited warranty service is required, PD will arrange for a technician to respond to the service call. For Dealers, PD will provide authorization for the service call based on the limitations in the Service Contract.

If PD’s authorized technician determines that the problem with the Product is not covered by this limited warranty, the customer will be charged for the technician’s travel expenses and labor costs at the then current hourly rate for the technician’s services.

- b. Service during the Remaining Term of the Limited Warranty Period. During the remaining term of the Limited Warranty Period, you must contact the PD Service Group at 608-216-9295 for service. A PD service technician will determine if the unit qualifies for limited warranty repairs.

Once the determination is made to be defective in material or workmanship, the Company will issue you a Returned Material Authorization (**RMA**) Number. PD will not service any part sent to the company without an **RMA Number**. After you receive the **RMA Number**, you must ship the part to

Power Designers USA LLC  
4005 Felland Road, Suite 116  
Madison WI 53718  
Attention: Warranty Service  
RMA # \_\_\_\_\_

The **RMA number** needs to be clearly marked on the outside of the shipment. The shipper is responsible for shipping the part freight prepaid to PD and for insuring the shipment and accepting the risk of loss or damage during shipment.

- c. PD shall determine in its sole discretion when tested under PD’s supervision, whether the Product contains defective materials or workmanship during the Warranty Period. If PD determines that the Product is defective, it shall, at its option, either (a) repair the Product at its expense, or (b) furnish a suitable replacement Product. Replaced or repaired Product shall be warranted for the remaining term of the original Warranty Period.
    - d. Upon completion of said repairs, the part will be returned by regular ground shipping, freight prepaid. If you desire expedited shipping, you must request such from PD and you will be responsible for prepaying the cost of such expedited shipping.

If a “component” or “components” failed due to any cause that the limited warranty does not cover, the owner (Dealer) will be informed of the charges of the repairs before any repairs are performed. If the repairs are approved, PD will repair said product with “new” or “reconditioned to new” parts at PD’s discretion. Outbound freight from PD will be the responsibility of the owner (Dealer).

2. The occurrence of any of the following events or actions shall render this Product Limited Warranty void:
  - a. Improper installation of the Product;
  - b. Use of the Product for a purpose other than its intended purpose;
  - c. Failure to follow PD’s instructions concerning proper installation or use of the Product;
  - d. The negligence of a person or entity other than PD in the installation or use of the Product; and
  - e. Repair or modifications of the Product by any party other than PD or one of its authorized agents.
3. PD MAKES NO OTHER REPRESENTATION OR WARRANTY WHATSOEVER, EXPRESS OR IMPLIED OR OF ANY NATURE, WITH REGARD TO THE PRODUCT, INCLUDING, WITHOUT LIMITATION, MERCHANTABILITY OR FITNESS FOR A PARTICULAR PURPOSE. THE REMEDY SET FORTH IN THIS POWERCHARGE LIMITED WARRANTY IS THE EXCLUSIVE REMEDY FOR ANY BREACH OF WARRANTY.
4. PD SHALL NOT BE LIABLE FOR ANY SPECIAL, INDIRECT, INCIDENTAL, CONSEQUENTIAL, PUNITIVE OR EXEMPLARY DAMAGES OF ANY KIND, INCLUDING, BUT NOT LIMITED TO, ANY LOST PROFITS AND LOST SAVINGS, LOSS OF USE OR INTERRUPTION OF BUSINESS, HOWEVER CAUSED, WHETHER ARISING IN CONTRACT, TORT (INCLUDING NEGLIGENCE), BREACH OF WARRANTY, STRICT LIABILITY OR OTHERWISE, EVEN IF PD HAS BEEN ADVISED OF THE POSSIBILITY OF SUCH DAMAGES. IN NO EVENT WILL PD BE LIABLE FOR THE COST OF PROCUREMENT OF SUBSTITUTE GOODS.
5. PD will defend, indemnify, and hold Buyer harmless from and against any claim, demand, or cause of action (including expenses, costs and damages related to the same) (each a “Claim”) in an amount not to exceed the Aggregate Limit brought against Buyer by any third party to the extent the Claim is based on the allegation that the Products infringe or violate the intellectual property rights of any third party, provided that (1) Buyer promptly notifies PD in writing of any Claim within 10days after Buyer becomes aware of any such Claim or the potential that a third party may assert such a Claim; (2) PD has sole control of the defense and all related settlement negotiations; and (3) on PD’s request, Buyer reasonably cooperates with and assists PD in the defense of any such Claim or potential Claim. As used above, the term “Aggregate Limit” means the aggregate dollar amount of the Products bought by the Buyer within the previous 12 month period prior to the date the Buyer notified PD of the Claim. Notwithstanding the above, PD shall have not any obligation to indemnify Buyer hereunder (a) for any settlement of the Claim made by Buyer without PD’ written permission, or (b) if, to the extent, such Claim is based on, in whole or in part, the alteration of the Products not approved by PD or the combination, operation, or use of the Products with devices, materials, parts, or software and documentation not supplied by PD, or (c) any use of the Product which is not customary or in compliance with PD’s designs, specifications, instructions, User’s Guide, or these terms and conditions. This states PD’s total responsibilities, liabilities and remedies to Buyer for any actual or alleged infringement of any intellectual property rights of any third party.
6. This Product Limited Warranty may be assigned to any end-user of the Product by Distributor in connection with sale of the Product by Distributor to such end-user, but may not be transferred or assigned by any end user or other entity or person.

# SOFTWARE LICENSE AGREEMENT

This license agreement is a legal agreement between Power Designers USA LLC of Madison, Wisconsin, the author and licensor of the software, and the end user licensee of the software.

Installation or other use of this software by the licensee constitutes agreement to all terms and conditions of this license. In the event the licensee does not agree to all terms and conditions of this agreement the software may not be installed or otherwise used.

The following terms apply:

1. Licensee may not redistribute any files, including but not limited to any setup or installation files created by this software.
2. Licensee may not disassemble or reverse engineer any part of this software.
3. Licensee may not resell, rent or lease the software.
4. Licensor owns all rights in the software including any incorporated images or text.
5. Should the licensee fail to comply with any terms or conditions of this agreement this agreement will immediately and automatically terminate without notice.
6. The licensor of this software does not guarantee that this software is free from bugs or free from viruses.

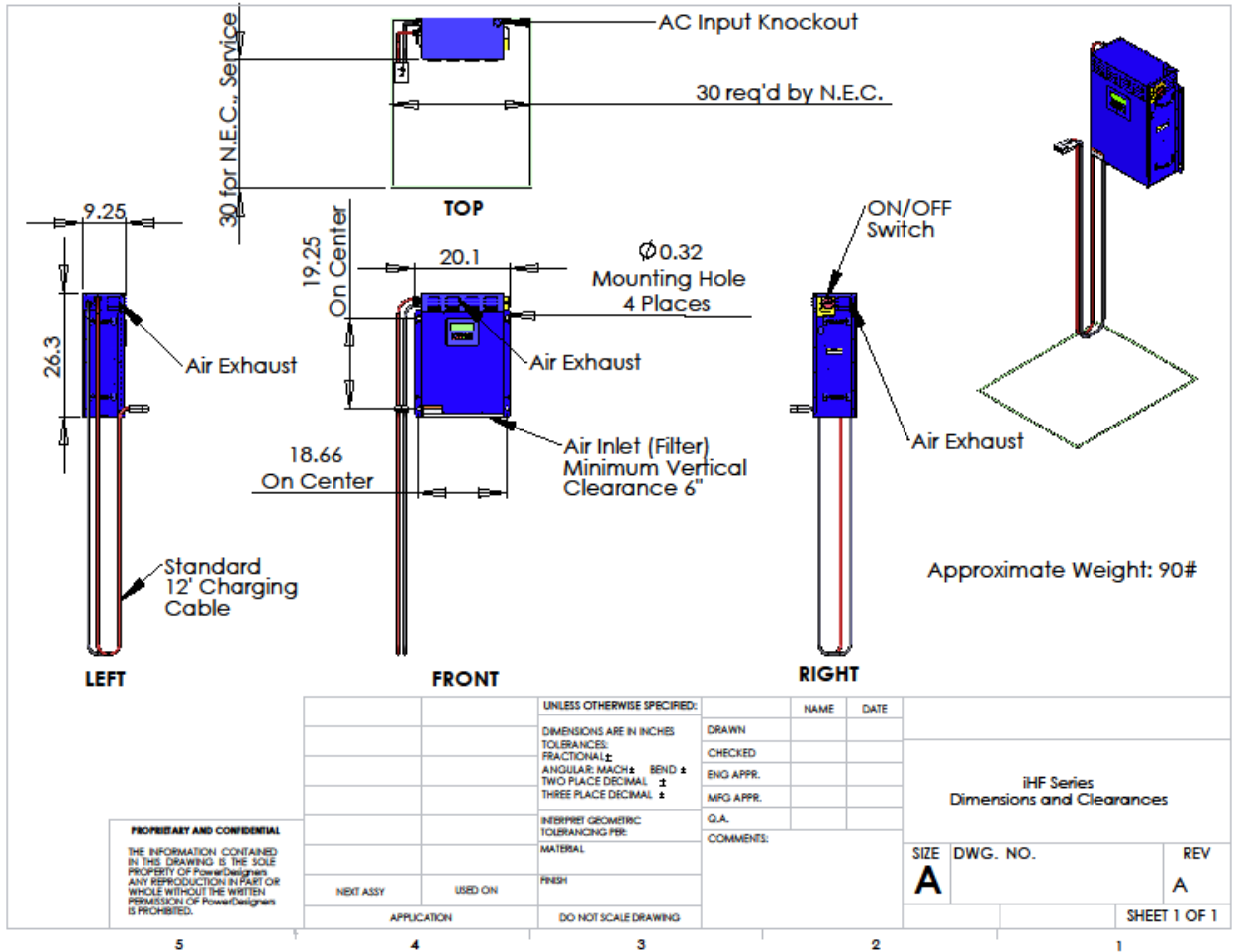
To the maximum extent permitted by applicable law, the software and documentation are provided "as is" and the licensor disclaims all other warranties and conditions, expressed or implied, including, but not limited to, implied warranties of merchantability, fitness for a particular purpose, conformance with description, title and non-infringement of third party rights.

To the maximum extent permitted by applicable law, in no event shall the licensor be liable for any indirect, incidental, consequential, special or exemplary damages or lost profits whatsoever (including, without limitation, damages for loss of business profits, business interruption, loss of business information, or any other pecuniary loss) arising out of the use or inability to use the software product, even if the licensor has been advised of the possibility of such damages. In any case, the licensors' cumulative and entire liability to the licensee or any other party for any loss or damages resulting from any claims, demands or actions arising out of or relating to this agreement shall not exceed the purchase price paid for this license.

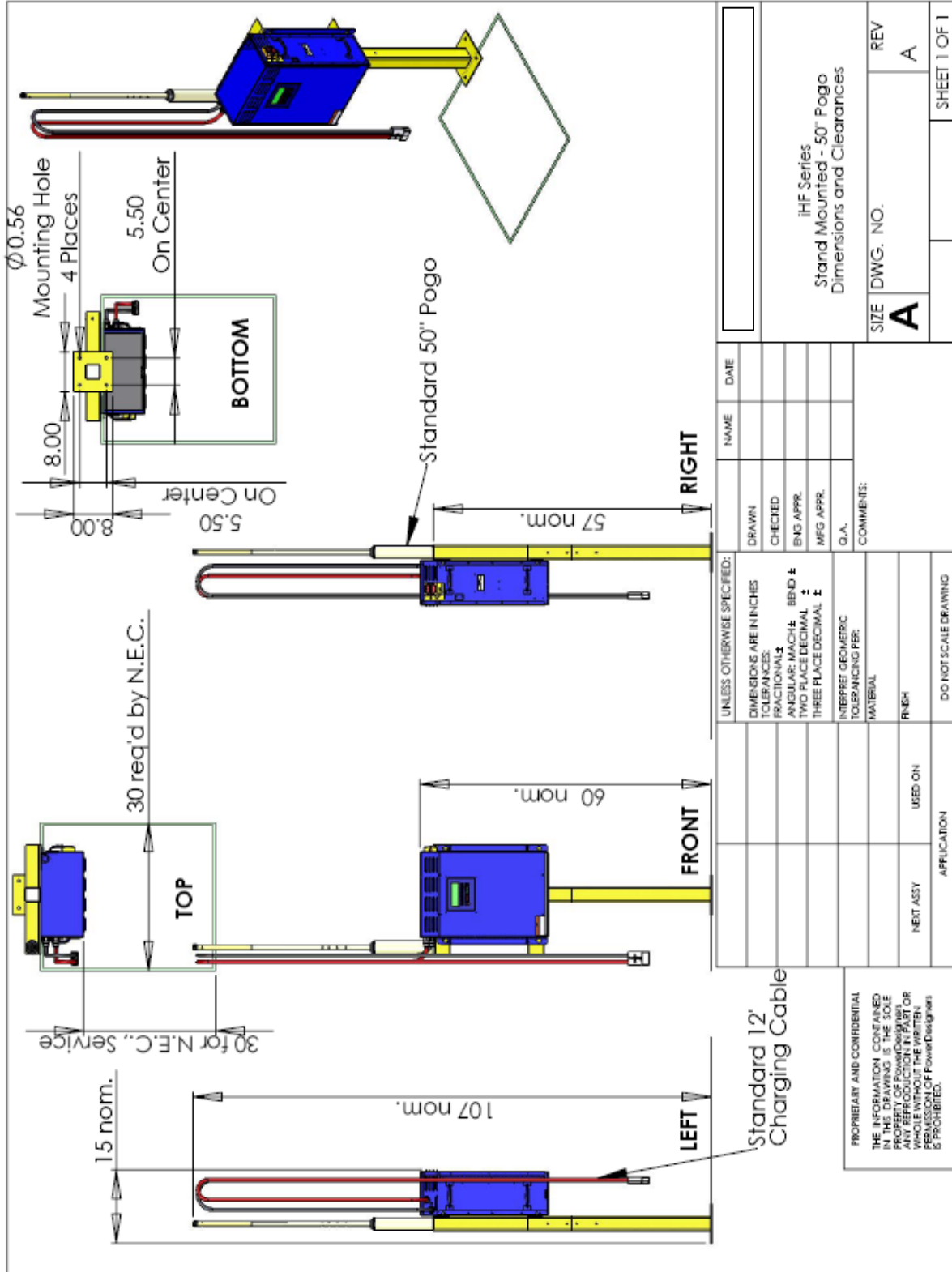
Should any term of these terms and conditions be declared void or unenforceable by any court of competent jurisdiction, such declaration shall have no effect on the remaining terms hereof.



# APPENDIX A – WALL MOUNT DIMENSIONS AND CLEARANCES



# APPENDIX B – POST STAND DIMENSIONS AND CLEARANCES

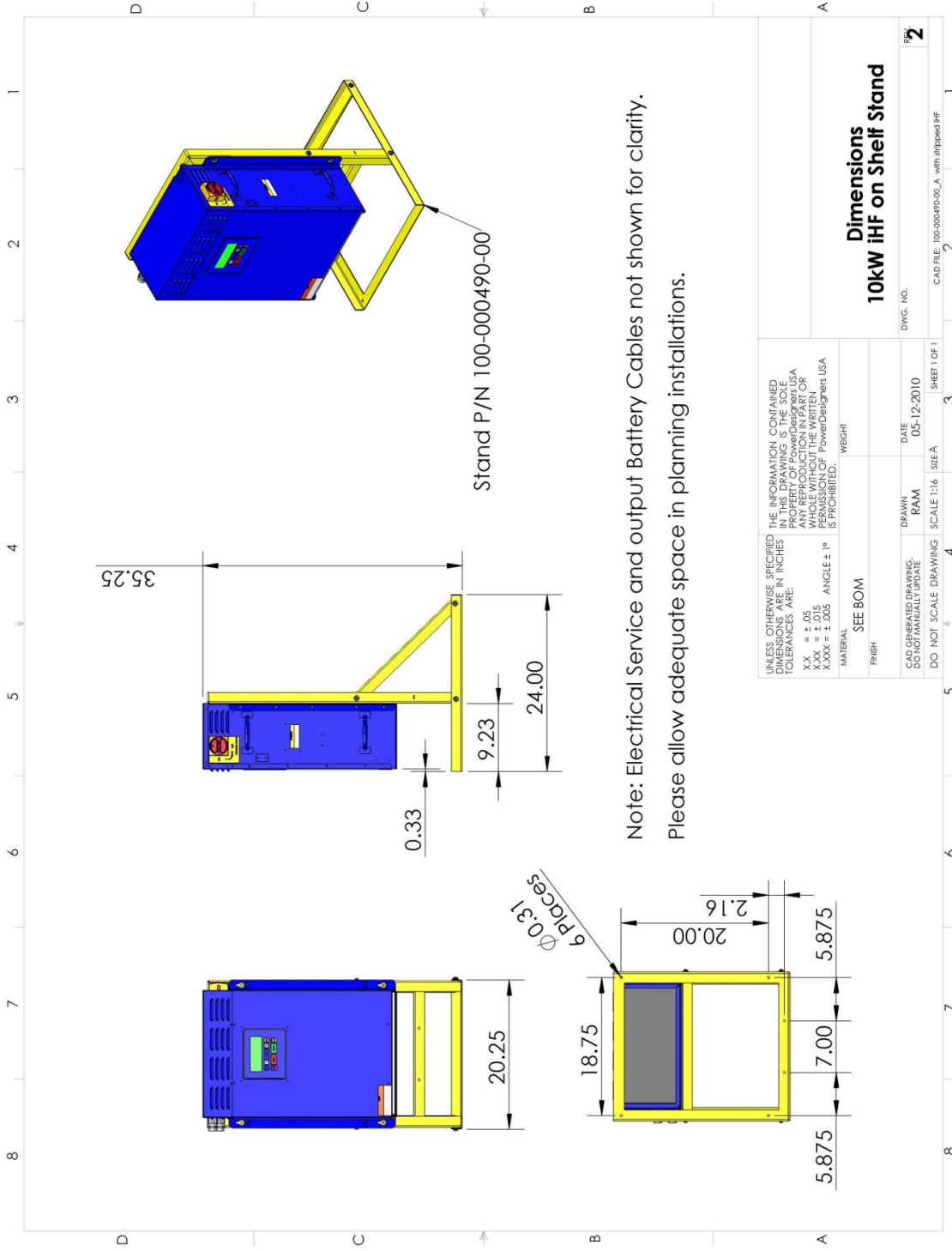


UNLESS OTHERWISE SPECIFIED:		NAME	DATE
DIMENSIONS ARE IN INCHES	DRAWN		
TOLERANCES:	CHECKED		
FRACTIONAL ±	ENG. APPR.		
ANGULAR MACH ±	MFG APPR.		
TWO PLACE DECIMAL ±	Q.A.		
THREE PLACE DECIMAL ±	COMMENTS:		
INTERPRET GEOMETRIC TOLERANCING PER:			
MATERIAL:			
FINISH:			
NEUT ASSY	USED ON		
APPLICATION	DO NOT SCALE DRAWING		

iHF Series Stand Mounted - 50" Pogo Dimensions and Clearances	
SIZE DWG. NO.	REV
<b>A</b>	A

# APPENDIX C – SHELF STAND DIMENSIONS AND CLEARANCES



## APPENDIX D – RECOVERY CYCLE FOR SULFATED BATTERY CURRENT AND TIMER SETTINGS

When running a recovery cycle for a sulfated battery, use this table as a guide when setting currents and timers.

Battery Capacity Ah	Current Setting A	Timer Setting HH:MM
250	15	16:45
375	20	18:45
500	25	20:00
750	40	18:45
1000	50	20:00
1150	60	19:00
1360	60	24:00

If the capacity for the battery you wish to recover is not listed in the table, use the following procedure to calculate first the recovery cycle current setting and then the timer setting. **NOTE: Do not attempt to recover a battery with a capacity of less than 250 Ahrs.**

1. Current = (battery capacity in Ahrs)/(100 Ahrs) x (5 A)
2. If necessary, round up the current **ONLY** to the next highest current in increments of 5 A. For capacities over 1200 Ahrs, select 60 A (the maximum value allowed)
3. Time =  $\frac{\text{battery capacity in Ahrs}}{\text{current}}$
4. If necessary, round the time to the nearest increment of 15 minutes. For capacities over 1200 Ahrs, select 24 hours (24:00)
5. If the time calculated is greater than 24 hours (the maximum timer setting allowed), a second cycle is recommended with the timer reset for the time over 24 hours (e.g., if you calculate 33.33 hours, a second cycle at 60A with the timer set for approximately 9.33 hours—closest setting 9:15—could be used)

Example:

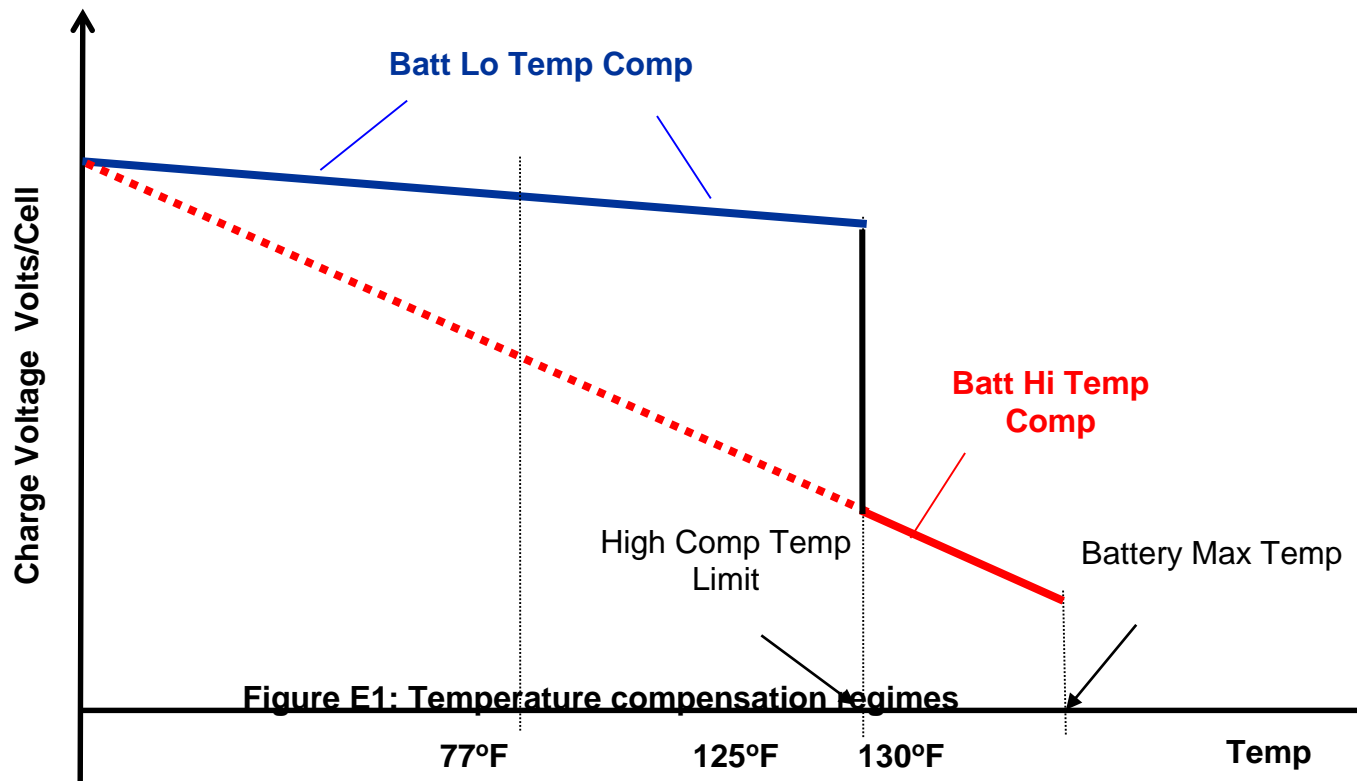
- a. Battery capacity = 850 Ahrs
- b. Current = (850 Ahrs)/(100 Ahrs) x (5 A) = 8.5 x 5 A = 42.5 A; current setting must be in increments of 5 A, so select 45 A.
- c. Time =  $\frac{850 \text{ Ahrs}}{45 \text{ A}} = 18.89 \text{ hrs}$
- d. The timer should be set for 19 hrs 0 min (19:00)

## APPENDIX E – NOTE ON TEMPERATURE COMPENSATION

Temperature compensation is critical to maintaining battery life and performance. If the battery temperature is allowed to drift higher or lower than 77°F during normal operation, the charger constant voltage limit should be adjusted to compensate for temperature variations.

For a valve regulated lead acid battery, the temperature compensation factor is 2 mV/°C/VPC. The **PowerCharge™ iHF3** fast charger implements two temperature-compensation coefficients:

1. The low battery compensation coefficient (**Batt Low Temp Comp**) is activated when the battery temperature is different than 77°F, but lower than the high compensation temperature limit (**High Comp Temp**) (Figure E1).
2. The battery high compensation coefficient (**Batt High Temp Comp**) is activated when the battery temperature is higher than the high compensation temperature limit (**High Comp Temp**) (Figure E1).



# CONTACTING POWER DESIGNERS USA LLC

**Power Designers USA LLC**  
4005 Felland Road, Suite 116  
Madison, WI 53718  
USA

[www.powerdesigners.com](http://www.powerdesigners.com)

[sales@powerdesigners.com](mailto:sales@powerdesigners.com)

[service@powerdesigners.com](mailto:service@powerdesigners.com)

Main Office Phone: 608.231.0450  
Main Office Fax: 608.231.9979  
Service Department: 608.216.9295

Phones are answered between 9 a.m. and 5 p.m., Monday through Friday Central Time. After-hours calls are answered by voice mail and returned on the next business day. Questions and comments can also be submitted via fax or email.